

Idaho Broadband Fund: CARES Act Broadband Grant

| | |
|-------------------|---|
| Applicant | Lura Baker |
| Applicant ID | APP-004783 |
| Company Name | Custer County |
| Recipient Address | Custer County Main St Challis, ID 83226 |
| Phone | (208) 879-2360 |
| Email | lbaker@co.custer.id.us |
| Amount Requested | \$840,101.00 |
| Status | Submitted |
| Funded | <input type="checkbox"/> |

Application Title: Custer Telephone Broadband Hotsprings

Applicant Information

NOTICE: Grant applications, challenges, and responses to challenges will be posted to the Idaho Department of Commerce website

1. Program Description

The Idaho Broadband Advisory Board is soliciting projects that meet the CARES Act funding criteria for the \$10 million appropriated to the Idaho Department of Commerce from the Federal COVID Relief Fund. These funds may only be expended to provide financial assistance in broadband infrastructure consistent with CARES Act criteria. The Idaho Broadband Advisory Board seeks to fund broadband projects across the state that are necessary for the COVID-19 public health emergency, and may include assisting with or improving distance learning, telehealth, telework, and public safety. This Idaho Broadband Fund: CARES Act Broadband Grant (the "Broadband Grant") is designed to meet the CARES Act criteria, helping Idaho rebound from the COVID-19 public health emergency.

Question: Applicant's contact information: a. Name b. Title/Position c. Mailing Address d. Email Address e. Phone Number

Lura Baker, Custer County Clerk, PO Box 385, Challis ID 83226
(208) 879-2360 Ext 4

Question: List the cities/communities in the census blocks where the project(s) will take place.

Challis - Rural area of Challis Hot Springs

A portion of census blocks
160379602003
160379602002

Question: Grant Administrator a. Provide the name and title of the designated grant administrator. b. Provide the email address of the designated grant administrator. c. Provide the phone number of the designated grant administrator.

Jolie Turek Custer Economic Development Executive Director/ ED Pro
ceda@custertel.net
(208)833-6861

Project Requirements

2. Eligible Projects

A. To be eligible for funding under the Broadband Grant, projects must meet the following eligibility criteria:

- Projects must satisfy the CARES Act criteria, which is designed to address key areas of public health and safety by improving opportunities to telework, improving access to telehealth services, facilitating distance learning, and improving public safety (CARES Act Federal Register Guidance can be found here. Frequently asked questions can be referenced here.)
- Projects must be necessary due to the COVID-19 public health emergency.
- Projects must expand rural broadband capacity to assist with telework, telehealth, distance learning, and public safety. Projects that would not be expected to increase capacity to a significant extent until the need for telework, telehealth, distance learning, and public safety have passed due to this public health emergency would not be necessary due to the public health emergency and therefore would not be eligible uses of Broadband Grant funds. Projects must provide broadband service within the proposed project areas.
- Projects must be completed and operable and verified no later than December 31, 2021. **Projects that are not completed, operable, and verified by December 31, 2021 will not be reimbursed.**
- Include broadband infrastructure and equipment costs meeting CARES Act criteria. Satellite service is not eligible for grant award.

Eligible applicants may apply for multiple grants. County governments may apply for grants on behalf of unincorporated communities.

Question: Does your project meet the CARES Act criteria?

Yes

No

Question: I understand that the State of Idaho will provide no funding and have no obligations for CARES funded projects that fail to be completed by December 31, 2021.

Yes

No

Scored Criteria

Scored Criteria

1. Provide an overview of the project, including why the project is important and how it will address the broadband needs of the community. Include a scope of work description, along with a list of ISPs that can provide: the broadband service being sought, the required technologies and equipment, and the installation and operation of the new broadband service. (30 Points)
 - a. Scope of Work: outlines the detailed plans of the infrastructure build. This may include, but is not limited to, the following: project area, type of infrastructure installed, locations of underserved households, known existing infrastructure, known existing anchor institutions (schools, hospitals, public facilities, etc.), potential middle-mile infrastructure that will be utilized, and locations of existing infrastructure.
2. Explain how the project will promote equal access in economic development, public safety, telehealth, education, including why current infrastructure is inadequate or negatively impacts the community? (25 Points)
3. Explain how your project meets Cares Act Criteria, is necessary for the public health emergency, and mitigates similar disruptions in the future? (20 Points).
4. Will this project deliver broadband infrastructure to a rural Idaho population (less than 25,000) (Y/N) (15 Points).
5. Explain how your project delivers a cost-effective broadband infrastructure solution to the community (10 Points).

Question: Provide an overview of the project, including why the project is important and how it will address the broadband needs of the community. Include a scope of work description, along with a list of ISPs that can provide the proposed service.

Custer Telephone is a cooperative owned Eligible Telecommunications Carrier (ETC) operating in Challis and Salmon Idaho. We have operated in Challis since 1955 and in Salmon since 2006. We provide broadband internet access, voice, cellular, and networking to customers Custer and Lemhi counties. With the Idaho Broadband grant, we intend to add to our Fiber-To-The-Home network that offers gigabit performance and low latency broadband and voice services to 96 customers. This last mile project will install fiber optics from our distribution cabinet on HWY 93 for residents of the Upper Hot Springs area. Internet traffic from the subscriber's premises to the upstream Internet provider is on a 100% fiber network from end to end. We will utilize Gigabit Passive Optical Network (GPON) equipment to deliver this service to the customer. The GPON network will be supported by 10 Gigabit redundant Ethernet Ring Protection Switching rings and connecting to the public internet via fiber connection to Tier 1 network provider using redundant 10 Gb links.

We will install a Calix Gigaspire ONT to terminate the fiber at each customer premises. This ONT will support Internet (up to 1 Gbps) and SIP voice services. This ONT will also provide a managed 802.11ax WiFi router, supporting 2.4 and 5Ghz spectrum. This device will also be capable of running performance testing as needed. Customers subscribing to voice services will have availability of battery backup options starting at a minimum of eight hours service in the event of a power outage. This equipment is included with the internet service to the customer at no additional cost. The equipment used at all node and core locations have redundant uplinks

and cards, battery backup and/or generator support. We have spare service cards, and transport optics at our main offices in the event of a hardware failure. We use numerous tools and technologies such as SNMP sniffers / trackers and NetFlow as we monitor all critical links in the network, including all subscriber-facing ports. Our general rule of thumb is when a link is at 50% capacity, we need to start planning on upgrading or adding capacity. We are a Calix partner and use several of their software and cloud-based analysis and monitoring tools such as SMX, in addition to Metaswitch service monitoring systems for voice traffic.

As an ETC, we provide support to qualifying low- income customers through the Lifeline program. This will help the rural areas of our community have better access to broadband and provides the opportunity to work from home, go to school from home, and be able to have Tele-health appointments from home when needed. We saw these things become necessary need during COVID-19. This project will better prepare our community for the future.

Question: Explain how the project will promote equal access in economic development, public safety, telehealth, education, including why current infrastructure is inadequate or negatively impacts the community?

Due to this project's location, outside of city limits, this is a residential upgrade however there are many students, health care workers, government officials, and public safety workers who recently have needed to work or learn from home. Upgrading facilities in this area will allow those families to have better access to telecommuting, distance learning, and other advanced services.

Question: Explain how your project meets Cares Act Criteria, is necessary for the public health emergency, and mitigates similar disruptions in the future?

The Custer Telephone Broadband Project for the Hot Springs area will expand broadband infrastructure and is consistent with CARES Act criteria. This project will improve access to broadband for that area. Access to broadband has become so important since COVID-19 because of the need to connect for distance learning, telehealth, telework, and public safety. This project will give 96 homes that option and provide the infrastructure for future homes in that area.

Question: Will this project deliver broadband infrastructure to a rural Idaho population (less than 25,000)?

Yes

No

Question: Explain how your project delivers a cost-effective broadband infrastructure solution to the community?

Our project will utilize a fiber optic network which is a proven technology with an expected life span of 40-50 years. Fiber networks are specifically designed to reliably transport data. Current fiber equipment technology provides low latency speeds of 1 gigabit. As society requires faster data speeds and equipment technology develops, speeds in excess of 1 gigabit will be possible over the existing fiber network. While fiber optic networks have a higher up-front cost, the cost per customer of these connections over the life of the network is \$236 per year.

Additional Requested Information (if applicable)

Question: Please detail any project match included to complete this project.

Custer Telephone is contributing a minimum of 20% cash match on this project. (\$208,775)

Question: Estimated total project cost?

1048876.00

Question: Number of households that will be connected to broadband service under the scope of the grant if applicable? If not applicable please answer N/A.

96

Question: What is the average cost per household of new broadband service based on this project cost if applicable? If not applicable please answer N/A.

\$10,874

While fiber optic networks have a higher up-front cost, the cost per customer of these connections over the life of the network is \$236 per year.

Question: What is the maximum broadband speed that will be provided by the project?

Downloads of up to 1 Gig will be available.

Question: Are permits, permissions, and zoning requirements all obtainable in order for the project to be completed and paid for by December 31, 2021 if it is a CARES funded project? Please provide details.

Yes, all permitting and easements have been obtained and the project will be completed by December 31, 2021.

Question: Please describe who will be providing the broadband service and ownership of the broadband infrastructure..

Custer Telephone Co-op Inc

Question: Describe how the project will be administered and audited for completion, and how the accounting will be performed.

Custer Telephone will submit invoices and progress reports to CEDA. Jolie and Lura will review and approve for submission to Commerce. Jolie will meet with Custer Telephone Management when

necessary and when more info is needed. Custer Telephone, CEDA and Custer County will account for all funds and make sure all 3 records match and will work together to complete necessary reporting.

Question: Has your project area received or been awarded any federal funds (CAFII/RDOF/USDA Reconnect) in the past two years, or will it receive federal funding over the next two years? If so, explain why additional funding was/is necessary in the project area?

No

Question: Has your project area received state funds (Cares Act Broadband Grants, E-Rate, etc.) in the past two years? If so, please explain what state funds were received and why the additional state funding was necessary in the project area.

This particular project has not. We were awarded a broadband grant through Idaho Commerce last year for the Challis Creek area and it has been completed.

Question: Include any other relevant information as to why your project should be considered for funding.

Access to good, reliable broadband is essential in today's world, this pandemic has proved that to be more true. Our area is very rural. We are close to 3 hours away from any population base or city. The town of Challis is under 1000 people and our entire county's population is well under 4500 people. We are the 3rd largest county, land wise in Idaho. Custer County has a tax-base of under 3% and a small population. This makes funding for projects extremely difficult. We work hard to get funds for infrastructure and capital improvement projects. Well thought out projects to help move our communities forward are essential. Our rural residents need better access to broadband.

Question: Submit 10 or more, recent, fixed location Speed Tests. Applicants can choose which speedtest application to use across the proposed project area (if applicable).

[Challis Speed Test_Redacted.pdf](#) (7/12/2021 11:19 AM)

Attachments & Additional Supporting Documents

Upload Required Attachments & Additional Supporting Documents

Project Attachment Templates:

[CARES Act Certification](#)

[Grant Budget Template](#)

[Project Schedule Form](#)

[Letters of Support/Community match template](#)

Question: Project Area Identification Documentation: Applicant must upload supporting documents identifying the scope of work for the proposed project(s). Applicant must include

1Pdf & 1Shape/Kmz map clearly showing the location and details of the proposed project.

[Custer Network Diagram.pdf](#) (7/14/2021 12:24 PM)

[Challis Grant Boundary.kmz](#) (7/13/2021 4:23 PM)

[Project map.pdf](#) (7/8/2021 2:18 PM)

Question: Grant Budget Template: Complete, upload, and attach to the application a completed Grant Budget Template for the project that outlines each of the various costs.

[Idaho-Cares-Act-Broadband-Grant-Budget-Template.docx](#) (7/8/2021 4:28 PM)

Question: Project Schedule Form: Complete, upload, and attach to the application the Project Schedule Form.

[Idaho-Cares-Act-Broadband-Grant-Project-Schedule.pdf](#) (7/8/2021 4:27 PM)

Question: CARES Act Certification: Upload and attach to the application a notarized CARES Act Certification that this project meets the CARES Act criteria.

[CARES Cert Custer Co.docx](#) (7/13/2021 2:35 PM)

Question: Letters of Support: Upload and attach to the application any Letters of Support or Community Match documentation. (if applicable)

[CAHC support.pdf](#) (7/13/2021 2:28 PM)

[school support.pdf](#) (7/12/2021 11:17 AM)

[Spencer Ltr of Support.pdf](#) (7/8/2021 3:17 PM)

[Petersen Ltr of Support.pdf](#) (7/8/2021 3:14 PM)

[Koeppen Ltr of Support.pdf](#) (7/8/2021 3:12 PM)

[CACC Ltr of Support.pdf](#) (7/8/2021 3:10 PM)

[Match letter.pdf](#) (7/8/2021 2:36 PM)

Question: Letters of Commitments from Anchor Institutions: Upload and attach to application letters of commitments from community anchor institutions or public safety networks which will utilize your service if the project is funded. (if applicable)

No Attachments

Question: Community Broadband Plan: Upload and attach a copy of your Community Broadband Plan (if applicable).

No Attachments

Question: Any applicable Site Plans, studies, or photographs.

[Project map.pdf](#) (7/8/2021 3:25 PM)

Signature

Your identity has been authenticated through the login process with a unique email address and password available only to you. You agree that by typing your name, title and date below, you are electronically signing the application. By electronically signing the application, you acknowledge and represent that you understand and accept all the terms and conditions stated within the application and declare that the information provided is true and that the documents you are submitting in support of your application are genuine and have not been altered in any way.

Question: Type your name.

Lura Baker

Question: Type your title.

Custer County Clerk

Question: Type the submission date.

7/14/2021



Office: 208-879-2771 Fax: 208-879-5836 632 East Main St. P.O. Box 1130, Challis, ID 83226-1130 Email:
challischamber@custertel.net on the web: challischamber.com

July 7, 2021

Idaho Department of Commerce
Grants and Contracts Division
PO Box 83720
Boise, Idaho 83720

RE: Idaho Broadband Grant – CARES Act

To Whom It May Concern:

I am writing on behalf of the Challis Area Chamber of Commerce to express our organization's support of the Custer County and Custer Economic Development Association's (CEDA) application to receive a grant to fund expansion of broadband in our community.

This grant will help to bring fiber broadband access to residents living in our outlying areas. We have many students and work from home professionals who live in rural Custer County that have do not have access to broadband speeds necessary to support learning, commerce and telehealth. This grant will provide the resources necessary to help to remedy this situation.

Thank you for your consideration of this application.

Sincerely,

A handwritten signature in black ink that reads "Sherry Maestas".

Sherry Maestas





Challis Area Health Center

611 Clinic Road/PO Box 980
Challis, ID 83226
Ph: 208.879.4351
Fax: 208.879.5216

July 12, 2021

Idaho Department of Commerce
Grants and Contracts Division
PO Box 83720
Boise, Idaho 83720

RE: LETTER OF SUPPORT
Idaho Broadband Grant – CARES Act

To Whom It May Concern:

I am writing on the behalf of the Challis Area Health Center to express our organizations support of the Custer County and Custer Economic Development Associations application to receive a grant to fund the expansion of broadband in our community.

This project, if funded would help provide much needed fiber broadband access to our patients and residents living in our rural community. Due to the recent onset of the Covid-19 pandemic, our patients rely on the broadband infrastructure to receive much needed services.

It is difficult for rural areas, such as Challis (Custer County) to secure funding for our infrastructure. We are often faced with limited and expensive methods for managing and upgrading infrastructure. In most instances infrastructure upgrades far exceed available budgets.

We hope you look favorably upon their application. Your financial support will ensure the success of this project and help make a positive contribution to how we deliver healthcare and to our community. Should you have any questions or require further information, please do not hesitate to contact me at (208) 879-4351

Respectfully,

A handwritten signature in black ink, appearing to read 'Steve Rembelski', with a long horizontal flourish extending to the right.

Steve Rembelski
Chief Executive Officer
Challis Area Health Center

Commission
expires _____

SPENCER JENTRE

| | |
|-------------|---------------------------------|
| Account | 53100 |
| Location ID | 53100:139 HUNTER LN |
| Phone No. | 208-879-4325 |
| Email | jentre.spencer@custertel.com |
| Address | 139 HUNTER LN, CHALLIS, ID, USA |

[OOKLA Privacy Policy](#)

✔ Download Speed 14.14 Mbps (Good). Upload Speed 1.42 Mbps (Good)

Download Speed

YOUNG CARL

| | |
|-------------|---------------------------------|
| Account | 123500 |
| Location ID | 123500:136 HUNTER LN |
| Phone No. | 208-879-4793 |
| Email | - |
| Address | 136 HUNTER LN, CHALLIS, ID, USA |

Speedtest by Ookla



[OOKLA Privacy Policy](#)

✔ Download Speed 15.34 Mbps (Good). Upload Speed 1.83 Mbps (Good)

Download Speed

HANSEN DON J AND JULIE

| | | |
|-------------|--|--|
| Account | 183900 | |
| Location ID | 183900:1191 FOOTHILLS RD | |
| Phone No. | 208-879-6949 | |
| Email | - | |
| Address | 1191 FOOTHILLS RD, CHALLIS, ID, USA | |

[OOKLA Privacy Policy](#)

✔ Download Speed 15.07 Mbps (Good). Upload Speed 1.35 Mbps (Good)

Download Speed

DOPP BARRY J

| | |
|-------------|----------------------------------|
| Account | 139800 |
| Location ID | 139800:102 SKYLINE DR |
| Phone No. | 308-879-5536 |
| Email | bjdopp@custertel.net |
| Address | 102 SKYLINE DR, CHALLIS, ID, USA |

Speed Test (ran 0 second ago)



[OOKLA Privacy Policy](#)

🟢 Download Speed 10.04 Mbps (Good). Upload Speed 1.4 Mbps (Good)

Download Speed

KENYON JAMES E

| | |
|-------------|----------------------------------|
| Account | 917600 |
| Location ID | 917600:369 SKYLINE DR |
| Phone No. | 208-879-5465 |
| Email | - |
| Address | 369 SKYLINE DR, CHALLIS, ID, USA |

Speed Test(ran 0 second ago)



[OOKLA Privacy Policy](#)

✔ Download Speed 10.37 Mbps (Good). Upload Speed 1.45 Mbps (Good)

Download Speed

KOMINEK FAITH S

| | |
|-------------|----------------------------------|
| Account | 926200 |
| Location ID | 926200:405 SKYLINE DR |
| Phone No. | 308-879-1280 |
| Email | - |
| Address | 405 SKYLINE DR, CHALLIS, ID, USA |

Speed Test (ran 0 second ago)



[OOKLA Privacy Policy](#)

✔ Download Speed 10.18 Mbps (Good). Upload Speed 1.05 Mbps (Good)

Download Speed

BAUM GUY E

| | |
|-------------|--------------------------------------|
| Account | 583300 |
| Location ID | 583300:504 BLUEBIRD LN |
| Phone No. | 208-833-5992 |
| Email | - |
| Address | 504 BLUEBIRD LN, CHALLIS, ID, USA |

Speed Test (ran 0 second ago)



[OOKLA Privacy Policy](#)

✔ Download Speed 10.49 Mbps (Good). Upload Speed 1.51 Mbps (Good)

Download Speed

MITCHELL MARLEN D OR BILLIE J

| | |
|-------------|--------------------------------------|
| Account | 162100 |
| Location ID | 162100:560 BLUEBIRD LN |
| Phone No. | 208-879-6526 |
| Email | - |
| Address | 560 BLUEBIRD LN, CHALLIS, ID, USA |

Speed Test(ran 0 second ago)



[OOKLA Privacy Policy](#)

✔ Download Speed 10.18 Mbps (Good). Upload Speed 1.54 Mbps (Good)

Download Speed

SMITHERS STEVEN A

| | |
|-------------|-----------------------------------|
| Account | 593200 |
| Location ID | 593200:303 BLUEBIRD LN |
| Phone No. | 208-369-8421 |
| Email | stezer3@hotmail.com |
| Address | 303 BLUEBIRD LN, CHALLIS, ID, USA |

Speed Test (ran 0 second ago)



[OOKLA Privacy Policy](#)

✔ Download Speed 15.05 Mbps (Good). Upload Speed 1.5 Mbps (Good)

Download Speed

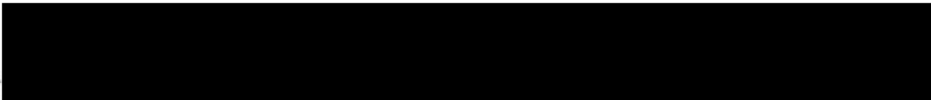



| | |
|-------------|---------------------------------|
| Account | 53100 |
| Location ID | 53100:139 HUNTER LN |
| Phone No. | [REDACTED] |
| Email | [REDACTED] |
| Address | 139 HUNTER LN, CHALLIS, ID, USA |

[OOKLA Privacy Policy](#)

✔ Download Speed 14.14 Mbps (Good). Upload Speed 1.42 Mbps (Good)

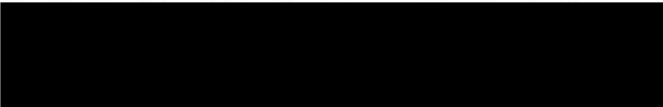
Download Speed



| | |
|-------------|--|
| Account | 123500 |
| Location ID | 123500:136 HUNTER LN |
| Phone No. |  |
| Email | - |
| Address | 136 HUNTER LN, CHALLIS, ID, USA |

Speedtest



[OOKLA Privacy Policy](#)

✔ Download Speed 15.34 Mbps (Good). Upload Speed 1.83 Mbps (Good)

Download Speed



| | | |
|-------------|--|--|
| Account | 183900 | |
| Location ID | 183900:1191 FOOTHILLS RD | |
| Phone No. | [REDACTED] | |
| Email | - | |
| Address | 1191 FOOTHILLS RD, CHALLIS, ID, USA | |

[OOKLA Privacy Policy](#)

✔ Download Speed 15.07 Mbps (Good). Upload Speed 1.35 Mbps (Good)

Download Speed



| | |
|-------------|----------------------------------|
| Account | 139800 |
| Location ID | 139800:102 SKYLINE DR |
| Phone No. | [REDACTED] |
| Email | [REDACTED] |
| Address | 102 SKYLINE DR, CHALLIS, ID, USA |

Speed Test (ran 0 second ago)



[OOKLA Privacy Policy](#)

🟢 Download Speed 10.04 Mbps (Good). Upload Speed 1.4 Mbps (Good)

Download Speed



| | |
|-------------|----------------------------------|
| Account | 917600 |
| Location ID | 917600:369 SKYLINE DR |
| Phone No. | |
| Email | - |
| Address | 369 SKYLINE DR, CHALLIS, ID, USA |

Speed Test (ran 0 second ago)



[OOKLA Privacy Policy](#)

✔ Download Speed 10.37 Mbps (Good). Upload Speed 1.45 Mbps (Good)

Download Speed



| | |
|-------------|----------------------------------|
| Account | 926200 |
| Location ID | 926200:405 SKYLINE DR |
| Phone No. | |
| Email | - |
| Address | 405 SKYLINE DR, CHALLIS, ID, USA |

Speed Test (ran 0 second ago)



[OOKLA Privacy Policy](#)

✔ Download Speed 10.18 Mbps (Good). Upload Speed 1.05 Mbps (Good)

Download Speed



| | |
|-------------|--------------------------------------|
| Account | 583300 |
| Location ID | 583300:504 BLUEBIRD LN |
| Phone No. | |
| Email | - |
| Address | 504 BLUEBIRD LN, CHALLIS, ID, USA |

Speed Test (ran 0 second ago)



[OOKLA Privacy Policy](#)

✔ Download Speed 10.49 Mbps (Good). Upload Speed 1.51 Mbps (Good)

Download Speed



| | |
|-------------|--------------------------------------|
| Account | 162100 |
| Location ID | 162100:560 BLUEBIRD LN |
| Phone No. | [REDACTED] |
| Email | - |
| Address | 560 BLUEBIRD LN, CHALLIS, ID, USA |

Speed Test (ran 0 second ago)



[OOKLA Privacy Policy](#)

✔ Download Speed 10.18 Mbps (Good). Upload Speed 1.54 Mbps (Good)

Download Speed

[REDACTED]

| | |
|-------------|-----------------------------------|
| Account | 593200 |
| Location ID | 593200:303 BLUEBIRD LN |
| Phone No. | [REDACTED] |
| Email | [REDACTED] |
| Address | 303 BLUEBIRD LN, CHALLIS, ID, USA |

Speed Test (ran 0 second ago)



[OOKLA Privacy Policy](#)

✔ Download Speed 15.05 Mbps (Good). Upload Speed 1.5 Mbps (Good)

Download Speed

Custer Telephone Cooperative Inc. FTTH Network Diagram

Proposed FTTH items
depicted in **GREEN**

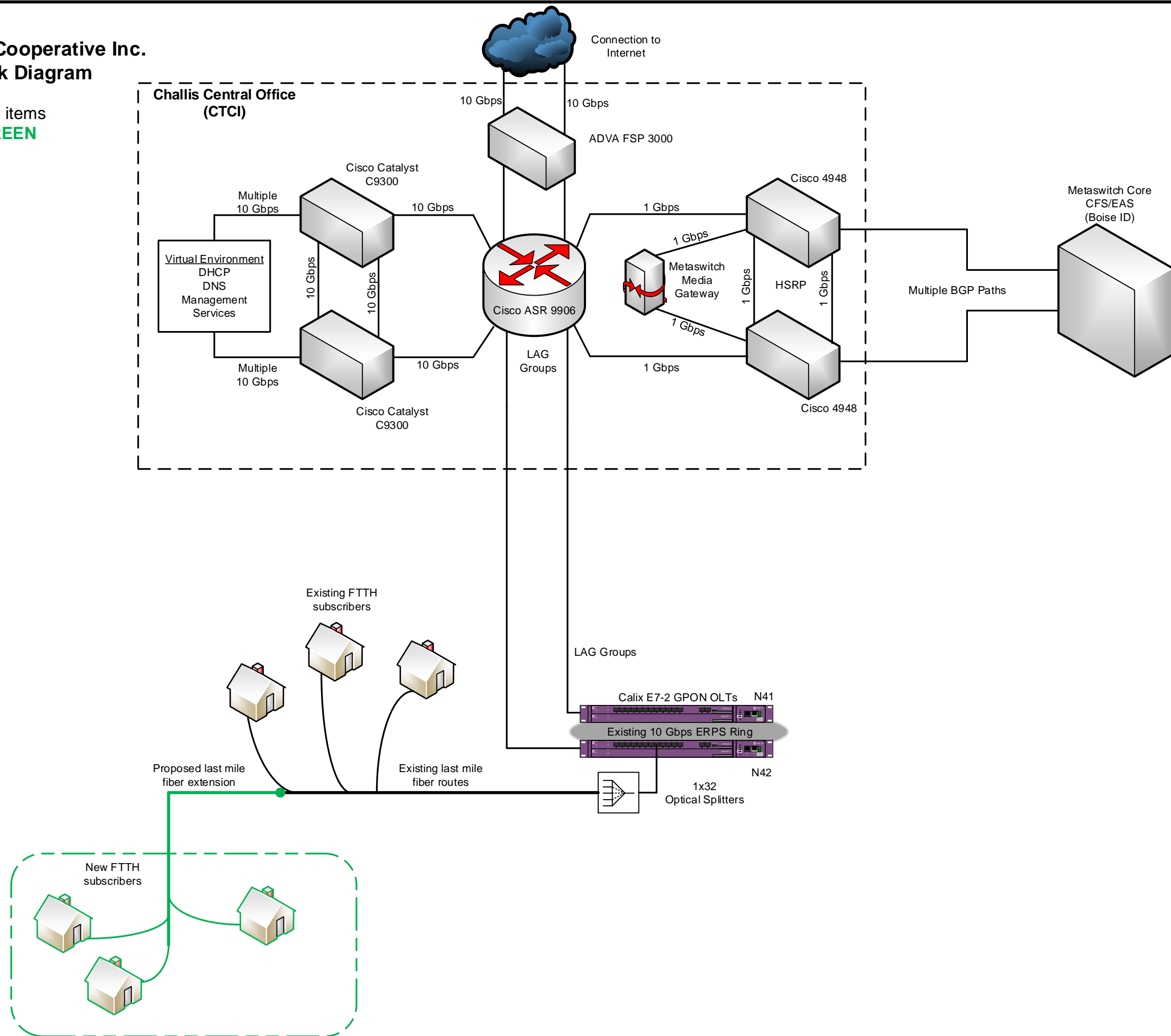

Idaho CARES Act Broadband Grant Budget

| Line Item | Grant Dollars | Match | | | Total |
|---------------------------|---------------|-----------|--|--|-------------|
| Custer Match | | \$208,775 | | | \$208,775 |
| Grant Admin | \$5000 | | | | \$5000 |
| Challis FTTH Construction | \$533,463 | | | | \$533,463 |
| Construction Materials | \$213,197 | | | | \$213,197 |
| Fiber Splicing | \$50,941 | | | | \$50,941 |
| Electronics | 37,500 | | | | \$37,500 |
| Totals | \$840,101 | | | | \$1,048,876 |
| | | | | | |

July 8, 2021

Krista Koeppen
987 Foothills Rd
Challis Idaho, 83226

Re: Idaho Broadband Grant

To Whom it May Concern:

I am in full support of the Custer Economic Development Association's (CEDA) grant application to bring faster broadband speeds to my home. We are a busy family of 4 that are always on the move and when we come home at night the last thing, we want is slow broadband with all our smart devices uploaded and downloaded. We have been waiting for our house to be connected to fiber for a few years now and we can't wait to upgrade our speeds and unleash the power of fiber.

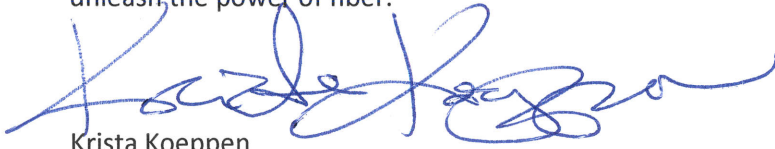
A handwritten signature in blue ink, appearing to read 'Krista Koeppen', is written over the end of the letter's text.

Krista Koeppen

Idaho CARES Act Broadband Grant
Match

Community: Challis Idaho

Contributor name (& title): JD Bennetts, CEO & General Manager

Agency/Business: Custer Telephone Cooperative, Inc.

DESCRIPTION OF DONATION:

Date: July 8, 2021

Self funded cost to build 2021 Upper Hot Springs Fiber to the Home project.

Total Amount Contributed to Project \$ 208,775

I hereby certify that the above listed contributions have been made in the amount (s) shown.



Contributor Signature

7/8/21

July 8, 2021

Boone Petersen
1325 Foothills Road
Challis Idaho, 83226

Re: Idaho Broadband Grant

To Whom it May Concern:

I am in full support of the Custer County's grant application to bring faster broadband speeds to my home. Faster speeds will allow my family to take advantage of new ways to connect with our doctor, which has been difficult during COVID. It will also allow us to work from home as needed. I can't wait until it's available and I can sign up for faster broadband.

Boone Petersen

A handwritten signature in black ink, appearing to read 'Boone Petersen', written in a cursive style.

July 8, 2021

Boone Petersen
1325 Foothills Road
Challis Idaho, 83226

Re: Idaho Broadband Grant

To Whom it May Concern:

I am in full support of the Custer County's grant application to bring faster broadband speeds to my home. Faster speeds will allow my family to take advantage of new ways to connect with our doctor, which has been difficult during COVID. It will also allow us to work from home as needed. I can't wait until it's available and I can sign up for faster broadband.

Boone Petersen

A handwritten signature in black ink, appearing to read 'Boone Petersen', written in a cursive style.

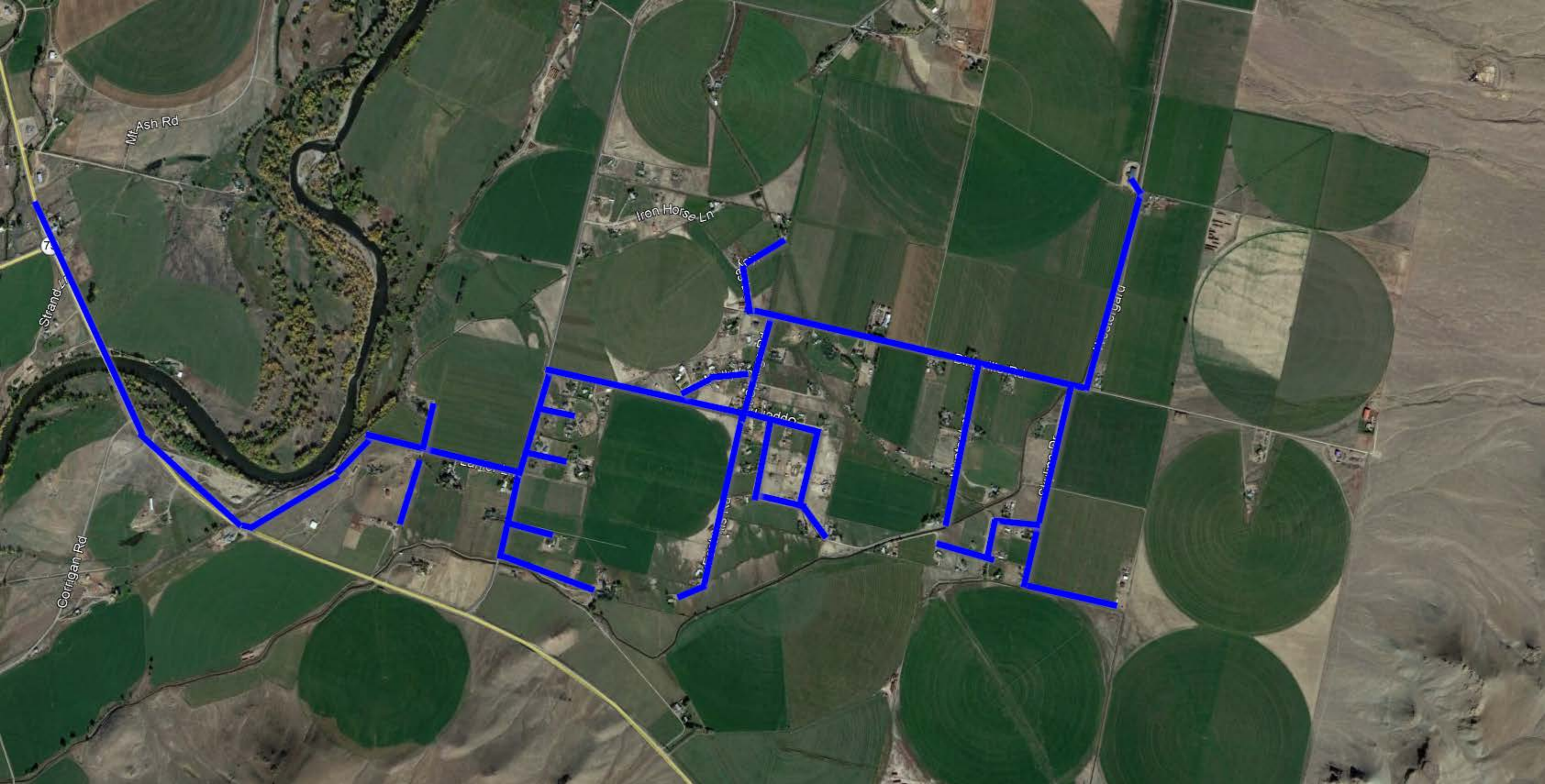

Mt Ash Rd

Strand Ln

Corrigan Rd

Iron Horse Ln

W 1st St

W 2nd St

W 3rd St

W 4th St

Christie Dr

Boerger Rd

W 5th St

W 6th St

W 7th St

W 8th St

W 9th St

W 10th St

W 11th St

W 12th St

W 13th St

W 14th St

W 15th St

W 16th St

W 17th St

W 18th St

W 19th St

W 20th St

W 21st St

W 22nd St

W 23rd St

W 24th St

W 25th St

W 26th St

W 27th St

W 28th St

W 29th St

W 30th St

W 31st St

W 32nd St

W 33rd St

W 34th St

W 35th St

W 36th St

W 37th St

W 38th St

W 39th St

W 40th St

W 41st St

W 42nd St

W 43rd St

W 44th St

W 45th St

W 46th St

W 47th St

W 48th St

W 49th St

W 50th St

W 51st St

W 52nd St

W 53rd St

W 54th St

W 55th St

W 56th St

W 57th St

W 58th St

W 59th St

W 60th St

W 61st St

W 62nd St

W 63rd St

W 64th St

W 65th St

W 66th St

W 67th St

W 68th St

W 69th St

W 70th St

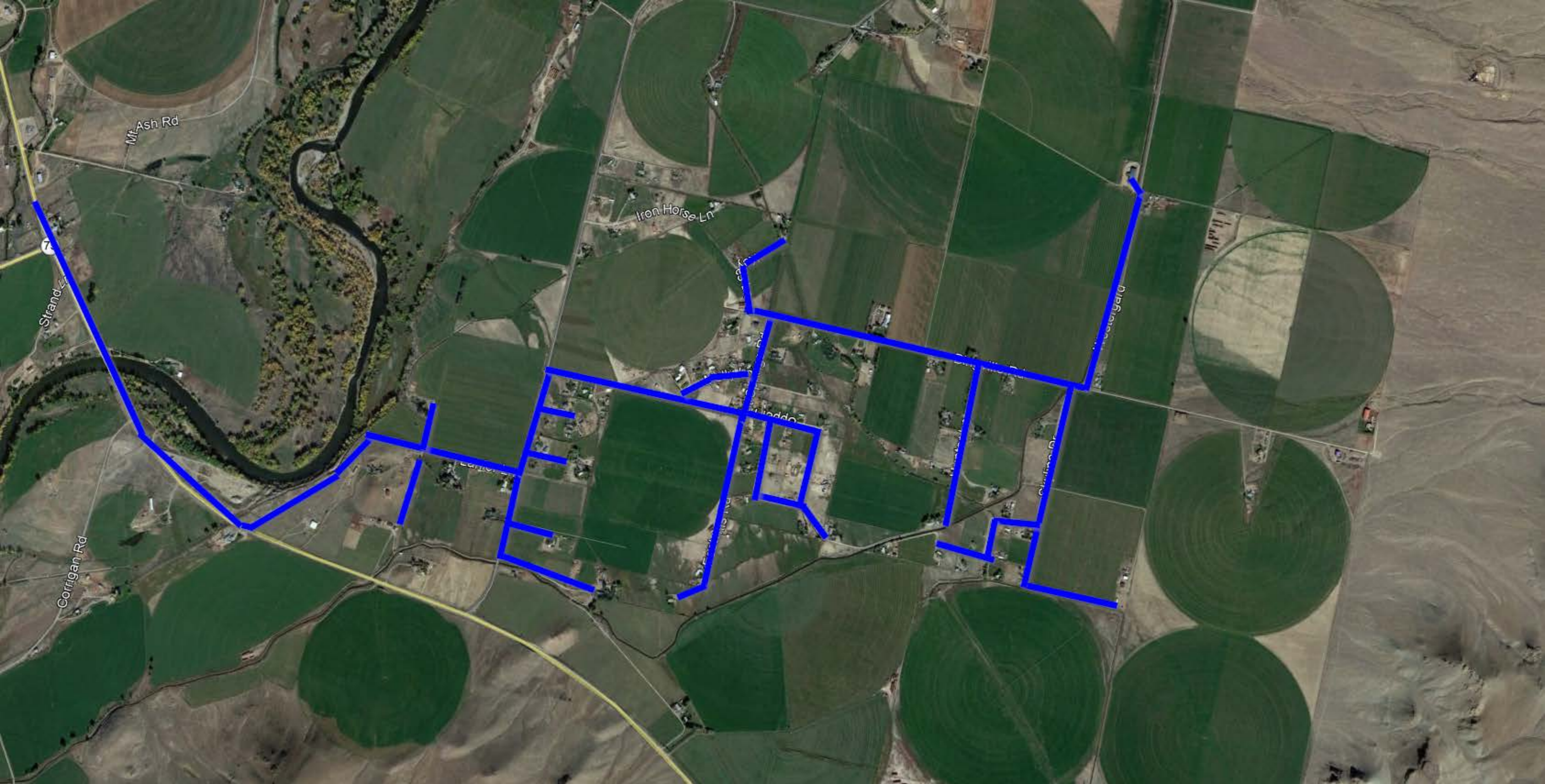

Mt. Ash Rd

Iron Horse Ln

Strand Ln

Corrigan Rd

W. 1st St

W. 2nd St

W. 3rd St

W. 4th St

W. 5th St

W. 6th St

W. 7th St

W. 8th St

W. 9th St

W. 10th St

W. 11th St

W. 12th St

W. 13th St

W. 14th St

W. 15th St

W. 16th St

W. 17th St

W. 18th St

W. 19th St

W. 20th St

W. 21st St

W. 22nd St

W. 23rd St

W. 24th St

W. 25th St

W. 26th St

W. 27th St

W. 28th St

W. 29th St

W. 30th St

W. 31st St

W. 32nd St

W. 33rd St

W. 34th St

W. 35th St

W. 36th St

W. 37th St

W. 38th St

W. 39th St

W. 40th St

W. 41st St

W. 42nd St

W. 43rd St

W. 44th St

W. 45th St

W. 46th St

W. 47th St

W. 48th St

W. 49th St

W. 50th St

W. 51st St

W. 52nd St

W. 53rd St

W. 54th St

W. 55th St

W. 56th St

W. 57th St

W. 58th St

W. 59th St

W. 60th St

W. 61st St

W. 62nd St

W. 63rd St

W. 64th St

W. 65th St

W. 66th St

W. 67th St

W. 68th St

W. 69th St

W. 70th St

W. 71st St

W. 72nd St

W. 73rd St

W. 74th St

W. 75th St

W. 76th St

W. 77th St

W. 78th St

W. 79th St

W. 80th St

W. 81st St

W. 82nd St

W. 83rd St

W. 84th St

W. 85th St

W. 86th St

W. 87th St

W. 88th St

W. 89th St

W. 90th St

W. 91st St

W. 92nd St

W. 93rd St

W. 94th St

W. 95th St

W. 96th St

W. 97th St

W. 98th St

W. 99th St

W. 100th St

W. 101st St

W. 102nd St

W. 103rd St

W. 104th St

W. 105th St

W. 106th St

W. 107th St

W. 108th St

W. 109th St

W. 110th St

W. 111th St

W. 112nd St

W. 113rd St

W. 114th St

W. 115th St

W. 116th St

W. 117th St

W. 118th St

W. 119th St

W. 120th St

W. 121st St

W. 122nd St

W. 123rd St

W. 124th St

W. 125th St

W. 126th St

W. 127th St

W. 128th St

W. 129th St

W. 130th St

W. 131st St

W. 132nd St

W. 133rd St

W. 134th St

W. 135th St

W. 136th St

W. 137th St

W. 138th St

W. 139th St

W. 140th St

W. 141st St

W. 142nd St

W. 143rd St

W. 144th St

W. 145th St

W. 146th St

W. 147th St

W. 148th St

W. 149th St

W. 150th St

W. 151st St

W. 152nd St

W. 153rd St

W. 154th St

W. 155th St

W. 156th St

W. 157th St

W. 158th St

W. 159th St

W. 160th St

W. 161st St

W. 162nd St

W. 163rd St

W. 164th St

W. 165th St

W. 166th St

W. 167th St

W. 168th St

W. 169th St

W. 170th St

W. 171st St

W. 172nd St

W. 173rd St

W. 174th St

W. 175th St

W. 176th St

W. 177th St

W. 178th St

W. 179th St

W. 180th St

W. 181st St

W. 182nd St

W. 183rd St

W. 184th St

W. 185th St

W. 186th St

W. 187th St

W. 188th St

W. 189th St

W. 190th St

W. 191st St

W. 192nd St

W. 193rd St

W. 194th St

W. 195th St

W. 196th St

W. 197th St

W. 198th St

W. 199th St

W. 200th St

W. 201st St

W. 202nd St

W. 203rd St

W. 204th St

W. 205th St

W. 206th St

W. 207th St

W. 208th St

W. 209th St

W. 210th St

W. 211st St

W. 212nd St

W. 213rd St

W. 214th St

W. 215th St

W. 216th St

W. 217th St

W. 218th St

W. 219th St

W. 220th St

W. 221st St

W. 222nd St

W. 223rd St

W. 224th St

W. 225th St

W. 226th St

W. 227th St

W. 228th St

W. 229th St

W. 230th St

W. 231st St

W. 232nd St

W. 233rd St

W. 234th St

W. 235th St

W. 236th St

W. 237th St

W. 238th St

W. 239th St

W. 240th St

W. 241st St

W. 242nd St

W. 243rd St

W. 244th St

W. 245th St

W. 246th St

W. 247th St

W. 248th St

W. 249th St

W. 250th St

W. 251st St

W. 252nd St

W. 253rd St

W. 254th St

W. 255th St

W. 256th St

W. 257th St

W. 258th St

W. 259th St

W. 260th St

W. 261st St

W. 262nd St

W. 263rd St

W. 264th St

W. 265th St

W. 266th St

W. 267th St

W. 268th St

W. 269th St

W. 270th St

W. 271st St

W. 272nd St

W. 273rd St

W. 274th St

W. 275th St

W. 276th St

Custer Telephone Cooperative Inc

Fiber to the Home Project Boundary 2021

93

Legend

 Feature 1

Challis

75

Google Earth

© 2021 Google



1 mi



Challis Joint School District #181

PO Box 304*Challis, Idaho 83226

July 9, 2021

Idaho Department of Commerce
Grants and Contracts Division
P.O. Box 83720
Boise, Idaho 83720

Re: Idaho Broadband Grant – CARES Act

To Whom it May Concern:

I am writing on behalf of the Challis School District to express our organization's full support for the Custer Economic Development Association's (CEDA) application to receive a grant to fund broadband expansion in our community. Their application meets the CARES Act criteria, which is designed to address key areas of public health and safety by improving opportunities to telework, facilitate distance learning, and improve public safety.

This grant will help bring Broadband access to our outlying communities. Many of our students live in rural parts of our county and need better access to reliable broadband to assist in their educational requirements.

COVID-19 caused our schools to move to online instruction for the months of April and May in 2020. Our special education students also received services through online capabilities to deliver speech/ language and occupational therapy services. The District is looking at online opportunities for our students, which is challenging for those students who do not have access to broadband services.

Awarding this grant would help deliver appropriate learning for all students in Challis School District.

I appreciate your consideration.

Sincerely,



Lani Rembelski
Superintendent, Challis School District #181

July 8, 2021

Jentre Spencer
139 Hunter Lane
Challis Idaho, 83226

Re: Idaho Broadband Grant

To Whom it May Concern:

I am in full support of the Custer Economic Development Association's (CEDA) grant application to bring faster broadband speeds to my home. We recently moved from an area that did have Fiber to an area that did not. We cannot wait to get it back! We are a family of 5 that uses a lot of bandwidth. Faster Speeds will allow all family members to access the internet without buffering. All three kids are in school so it will help them with homework or other learning options while still allowing my husband and I to access the internet for our needs.



Jentre Spencer

Idaho Broadband Fund: CARES Act Broadband Grant

| | |
|-------------------|---|
| Applicant | Brenda Armstrong |
| Applicant ID | APP-004786 |
| Company Name | Lemhi County |
| Recipient Address | Lemhi County 206 Courthouse Dr Salmon, ID 83467 |
| Phone | (208) 756-2815 x1667 |
| Email | clerk@lemhicountyidaho.org |
| Amount Requested | \$378,750.00 |
| Status | Submitted |
| Funded | <input type="checkbox"/> |

Application Title: South St. Charles & Cemetery Lane

Applicant Information

NOTICE: Grant applications, challenges, and responses to challenges will be posted to the Idaho Department of Commerce website

1. Program Description

The Idaho Broadband Advisory Board is soliciting projects that meet the CARES Act funding criteria for the \$10 million appropriated to the Idaho Department of Commerce from the Federal COVID Relief Fund. These funds may only be expended to provide financial assistance in broadband infrastructure consistent with CARES Act criteria. The Idaho Broadband Advisory Board seeks to fund broadband projects across the state that are necessary for the COVID-19 public health emergency, and may include assisting with or improving distance learning, telehealth, telework, and public safety. This Idaho Broadband Fund: CARES Act Broadband Grant (the "Broadband Grant") is designed to meet the CARES Act criteria, helping Idaho rebound from the COVID-19 public health emergency.

Question: Applicant's contact information: a. Name b. Title/Position c. Mailing Address d. Email Address e. Phone Number

Brenda Armstrong, Lemhi County Clerk, 206 Courthouse Drive, Salmon Idaho 83467.
brenda@lemhicountyidaho.org 208-742-1667

Question: List the cities/communities in the census blocks where the project(s) will take place.

Salmon, Idaho
A portion of census blocks
160599702001
160599702003
160599703002

Question: Grant Administrator a. Provide the name and title of the designated grant administrator. b. Provide the email address of the designated grant administrator. c. Provide the phone number of the designated grant administrator.

Tammy Stringham, Lemhi County Economic Development Association, Executive Director
director@LCEDA.net
803 Monroe Street
Salmon, ID 83467
208-756-1567

Project Requirements

2. Eligible Projects

A. To be eligible for funding under the Broadband Grant, projects must meet the following eligibility criteria:

- Projects must satisfy the CARES Act criteria, which is designed to address key areas of public health and safety by improving opportunities to telework, improving access to telehealth services, facilitating distance learning, and improving public safety (CARES Act Federal Register Guidance can be found here. Frequently asked questions can be referenced here.)
- Projects must be necessary due to the COVID-19 public health emergency.
- Projects must expand rural broadband capacity to assist with telework, telehealth, distance learning, and public safety. Projects that would not be expected to increase capacity to a significant extent until the need for telework, telehealth, distance learning, and public safety have passed due to this public health emergency would not be necessary due to the public health emergency and therefore would not be eligible uses of Broadband Grant funds. Projects must provide broadband service within the proposed project areas.
- Projects must be completed and operable and verified no later than December 31, 2021. **Projects that are not completed, operable, and verified by December 31, 2021 will not be reimbursed.**
- Include broadband infrastructure and equipment costs meeting CARES Act criteria. Satellite service is not eligible for grant award.

Eligible applicants may apply for multiple grants. County governments may apply for grants on behalf of unincorporated communities.

Question: Does your project meet the CARES Act criteria?

Yes

No

Question: I understand that the State of Idaho will provide no funding and have no obligations for CARES funded projects that fail to be completed by December 31, 2021.

Yes

No

Scored Criteria

Scored Criteria

1. Provide an overview of the project, including why the project is important and how it will address the broadband needs of the community. Include a scope of work description, along with a list of ISPs that can provide: the broadband service being sought, the required technologies and equipment, and the installation and operation of the new broadband service. (30 Points)
 - a. Scope of Work: outlines the detailed plans of the infrastructure build. This may include, but is not limited to, the following: project area, type of infrastructure installed, locations of underserved households, known existing infrastructure, known existing anchor institutions (schools, hospitals, public facilities, etc.), potential middle-mile infrastructure that will be utilized, and locations of existing infrastructure.
2. Explain how the project will promote equal access in economic development, public safety, telehealth, education, including why current infrastructure is inadequate or negatively impacts the community? (25 Points)
3. Explain how your project meets Cares Act Criteria, is necessary for the public health emergency, and mitigates similar disruptions in the future? (20 Points).
4. Will this project deliver broadband infrastructure to a rural Idaho population (less than 25,000) (Y/N) (15 Points).
5. Explain how your project delivers a cost-effective broadband infrastructure solution to the community (10 Points).

Question: Provide an overview of the project, including why the project is important and how it will address the broadband needs of the community. Include a scope of work description, along with a list of ISPs that can provide the proposed service.

The South St. Charles and Cemetery Lane Area of Salmon sit outside the city limits and has a sizable number of homes. During the pandemic many of the residents had to telework, had students that needed to use distance learning platforms and utilize telehealth options. Although the pandemic seems to be subsiding, the threat of new strains and jumps in positive cases continues to make appropriate broadband capacities necessary. Salmon has a large federal lands footprint and the agencies employ hundreds of people in Salmon, these agencies are still largely teleworking and will be into the foreseeable future.

Custer Telephone Broadband Service, LLC is a 100% wholly owned subsidiary of Custer Telephone Cooperative, Inc and is an Eligible Telecommunications Carrier (ETC) operating Salmon Idaho since 2006. They provide broadband internet access, voice, and networking to customers in Custer and Lemhi counties.

With the Idaho Broadband grant, they intend to add to their Fiber-To-The-Home network in Salmon that offers gigabit performance and low latency broadband and voice services to 58 customers. As an ETC, they provide support to qualifying low income customers through the Lifeline program.

This project is part 2 of a 2-year project to build out the South St Charles and Cemetery Lane area of Salmon. In 2020, they constructed the fiber middle mile in this area and installed fiber to 30 homes. In 2021, they will finish this project and install fiber to an additional 28 households. Internet traffic from the subscriber's premises to the upstream internet provider is on a 100% fiber network from end to end.

They will install fiber optic connections to each home in the project. These connections will be connected to their central office located in Salmon. They will utilize Gigabit Passive Optical Network (GPON) equipment to deliver service to the customer. The GPON network will be supported by 10 Gigabit redundant Ethernet Ring Protection Switching rings and connecting to the public internet via fiber connection to Tier 1 network provider using redundant 10 Gb links. They will install a Calix Gigaspire ONT to terminate the fiber at each customer premises. This ONT will support Internet (up to 1 Gbps) and SIP voice services. This ONT will also provide a managed 802.11ax WiFi router, supporting 2.4 and 5Ghz spectrum. This device will also be capable of running performance testing as needed. Customers subscribing to voice services will have availability of battery backup options starting at a minimum of eight hours service in the event of a power outage. This equipment is included with the internet service to the customer at no additional cost. The equipment used at all node and core locations have redundant uplinks and cards, battery backup and/or generator support. They have spare service cards, and transport optics at their main offices in the event of a hardware failure. They use numerous tools and technologies such as SMTP sniffers / trackers and NetFlow as they monitor all critical links in the network, including all subscriber-facing ports. their general rule of thumb is when a link is at 50% capacity, they need to start planning on upgrading or adding capacity. They are a Calix partner and use several of their software and cloud-based analysis and monitoring tools such as SMX, in addition to Metaswitch service monitoring systems for voice traffic.

Question: Explain how the project will promote equal access in economic development, public safety, telehealth, education, including why current infrastructure is inadequate or negatively impacts the community?

This infrastructure provides areas of rural Salmon with access to broadband speeds up to 1 gigabit which will provide the opportunity to work from home, go to school from home, and be able to have Tele-health appointments from home when needed. We saw these things become necessary need during COVID-19 which still remains relevant even today. This future proof project will better prepare our community to for future technology demands.

Question: Explain how your project meets Cares Act Criteria, is necessary for the public health emergency, and mitigates similar disruptions in the future?

This project meets the criteria for the CARES Act by helping supply sufficient broadband service for distance learning and have technological improvements that will help schools and students comply with COVID-19 precautions. This service will also help provide better access to Telehealth network services that require broadband and will ensure that telework capabilities are accessible to comply with COVID-19 public heath precautions.

Because the service being installed is fiber more bandwidth can be provided on demand as requirements grow larger.

Question: Will this project deliver broadband infrastructure to a rural Idaho population (less than 25,000)?

Yes

No

Question: Explain how your project delivers a cost-effective broadband infrastructure solution to the community?

The project will utilize a fiber optic network which is a proven technology with an expected life span of 40-50 years. Current fiber equipment technology provides low latency speeds of 1 gigabit. As society requires faster data speeds and equipment technology develops, speeds in excess of 1 gigabit will be possible over the existing fiber network. While fiber optic networks have a higher up-front cost, the cost over the life of the network can be as little as \$325 per customer per year.

Additional Requested Information (if applicable)

Question: Please detail any project match included to complete this project.

Custer Telephone Broadband Services will provide a 56% or \$474,883.00 in match.

Question: Estimated total project cost?

853633.40

Question: Number of households that will be connected to broadband service under the scope of the grant if applicable? If not applicable please answer N/A.

58

Question: What is the average cost per household of new broadband service based on this project cost if applicable? If not applicable please answer N/A.

\$14,653.00

Question: What is the maximum broadband speed that will be provided by the project?

1 Gigabit

Question: Are permits, permissions, and zoning requirements all obtainable in order for the project to be completed and paid for by December 31, 2021 if it is a CARES funded project? Please provide details.

Yes, All the necessary permits and permissions for this project have been obtained.

Question: Please describe who will be providing the broadband service and ownership of the

broadband infrastructure..

Custer Telephone Broadband Services, LLC will provide internet service and will own the fiber network and equipment.

Question: Describe how the project will be administered and audited for completion, and how the accounting will be performed.

The grant administrator will meet at least bi-weekly with Custer Telephone and Broadband, perform site visits, collect and review invoices with the county clerk and complete reimbursement paperwork for Lemhi County.

Question: Has your project area received or been awarded any federal funds (CAFII/RDOF/USDA Reconnect) in the past two years, or will it receive federal funding over the next two years? If so, explain why additional funding was/is necessary in the project area?

Custer Telephone and Broadband Services, LLC is currently in the RDOF Long Form Application process for a small portion of this project. Once approved, they should receive RDOF funding of \$14,652 over 10 years for the RDOF locations built as part of this project.

Question: Has your project area received state funds (Cares Act Broadband Grants, E-Rate, etc.) in the past two years? If so, please explain what state funds were received and why the additional state funding was necessary in the project area.

The project area has not received prior support from the Cares Act Broadband Grants or E-rate that we know of.

Question: Include any other relevant information as to why your project should be considered for funding.

This project should be considered for funding because Custer Telephone and Broadband Service is a local service provider committed to bringing fiber to rural Lemhi and Custer county. This grant would help them to provide broadband service to homes, businesses, schools and essential community facilities that otherwise do not have the option for broadband.

Question: Submit 10 or more, recent, fixed location Speed Tests. Applicants can choose which speedtest application to use across the proposed project area (if applicable).

[Salmon Speed Tests Redacted.pdf](#) (7/12/2021 3:45 PM)

Attachments & Additional Supporting Documents

Upload Required Attachments & Additional Supporting Documents

Project Attachment Templates:

[CARES Act Certification](#)

[Grant Budget Template](#)

[Project Schedule Form](#)

[Letters of Support/Community match template](#)

Question: Project Area Identification Documentation: Applicant must upload supporting documents identifying the scope of work for the proposed project(s). Applicant must include 1Pdf & 1Shape/Kmz map clearly showing the location and details of the proposed project.

[Salmon Grant Boundary File.kmz](#) (7/14/2021 12:48 PM)
[Salmon Project.pdf](#) (7/12/2021 3:47 PM)

Question: Grant Budget Template: Complete, upload, and attach to the application a completed Grant Budget Template for the project that outlines each of the various costs.

[Salmon custer budget 21.xlsx](#) (7/13/2021 1:26 PM)

Question: Project Schedule Form: Complete, upload, and attach to the application the Project Schedule Form.

[Custertel Project-Schedule.pdf](#) (7/12/2021 3:47 PM)

Question: CARES Act Certification: Upload and attach to the application a notarized CARES Act Certification that this project meets the CARES Act criteria.

[Lemhi Certification.pdf](#) (7/13/2021 1:20 PM)

Question: Letters of Support: Upload and attach to the application any Letters of Support or Community Match documentation. (if applicable)

[Heidi Semmler Letter of Support.pdf](#) (7/14/2021 12:49 PM)
[Cayla Sanderson- support of Grant.docx.pdf](#) (7/14/2021 12:49 PM)
[Match Letter.pdf](#) (7/12/2021 3:48 PM)

Question: Letters of Commitments from Anchor Institutions: Upload and attach to application letters of commitments from community anchor institutions or public safety networks which will utilize your service if the project is funded. (if applicable)

No Attachments

Question: Community Broadband Plan: Upload and attach a copy of your Community Broadband Plan (if applicable).

No Attachments

Question: Any applicable Site Plans, studies, or photographs.

[Salmon Network Map.pdf](#) (7/14/2021 12:48 PM)

Signature

Your identity has been authenticated through the login process with a unique email address and password available only to you. You agree that by typing your name, title and date below, you are electronically signing the application. By electronically signing the application, you acknowledge

and represent that you understand and accept all the terms and conditions stated within the application and declare that the information provided is true and that the documents you are submitting in support of your application are genuine and have not been altered in any way.

Question: Type your name.

Brenda Armstrong

Question: Type your title.

Lemhi County Clerk

Question: Type the submission date.

7-14-21

July 14, 2021

Cayla Sanderson
7 Adams Drive
Salmon, Idaho 83467

To Whom it May Concern:

I am in full support of the Lemhi County's grant application under the Idaho Broadband Grant program to bring faster broadband speeds to my home. I am an artist who runs my business out of my home and having the fastest internet makes my business run more efficiently. It's refreshing to know that no matter what chaos the day holds, I will be able to rely on quick internet speeds to communicate with clients and keep up to date on my sales. In a town so far from most everything else including decent cell service, my fiance and I rely heavily on the internet and I hope you choose to give out this Grant to our service provider.

Thanks for your time,

Cayla Sanderson

Heidi Semmler
47 Wagon Wheel Road
Salmon, ID 83467
July 13, 2021

RE: Idaho Broadband Grant

To Whom it May Concern:

I wanted to reach out to express my support for the Lemhi County application to receive a grant to fund broadband expansion to my neighborhood. This will benefit the community greatly to receive quicker internet services and will give us the ability and the options to stream different services.

Thank you,
Heidi Semmler

State of Idaho Broadband Grant CARES Act Certification

STATE OF IDAHO

COUNTY OF LEMHI

The undersigned, Brenda Armstrong, representing Lemhi County, 206 Courthouse Drive, Salmon Idaho, hereby swear (affirm) that:

1. I am County Clerk of Lemhi County and thereby authorized to make these statements.
2. I have personal knowledge of the facts herein, and can testify completely thereto.
3. The purpose of this statement is to assure the Idaho Department of Commerce that the project will meet the CARES Act Criteria.
 - i. Expenses to facilitate distance learning, including technological improvements, in connection with school closings to enable compliance with COVID-19 precautions.
 - ii. Expenses to improve telework capabilities for public employees to enable compliance with COVID-19 public health precautions.

This project meets the criteria for the CARES Act by helping supply sufficient broadband service for distance learning and have technological improvements that will help schools and students comply with COVID-19 precautions. This service will also help provide better access to Telehealth network services that require broadband and will ensure that telework capabilities are accessible to comply with COVID-19 public health precautions.

Brenda Armstrong
Signature

7/12/21
Date

SUBSCRIBED AND SWORN before me on this 12 day of July 2021

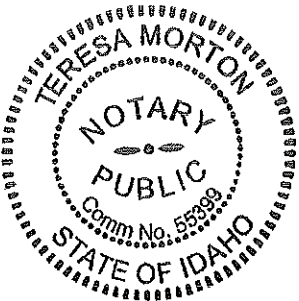

Teresa Morton
Notary Public for STATE
Residing at Salmon Id
Commission expires 11/23/21

Idaho CARES Act Broadband Grant
Match

Community: Salmon Idaho

Contributor name (& title): JD Bennetts, President

Agency/Business: Custer Telephone Broadband Services, LLC

DESCRIPTION OF DONATION:

Date: July 8, 2021

Self funded cost to build 2020 portion of South St. Charles Fiber to the Home project.

Total Amount Contributed to Project \$ 474,883.00

I hereby certify that the above listed contributions have been made in the amount (s) shown.

Contributor Signature

7/8/21

Idaho CARES Act Broadband Grant Budget

| Line Item | Grant Dollars 2021 | Match 2020 | Total |
|-----------------------------|-----------------------|---------------|------------|
| Construction | 253,829.00 | 296,921.00 | 550,750.00 |
| Engineering/Construction Ma | 53,150.00 | 75,904.00 | 129,054.00 |
| Materials | 43,907.00 | 59,142.64 | 103,049.64 |
| Splicing | 12,970.00 | 32,382.00 | 45,352.00 |
| Electronics | 11,144.00 | 10,533.76 | 21,677.76 |
| Project Total | 375,000.00 | 474,883.40 | 849,883.40 |
| Admin | 3,750.00 | | |
| Grant Total | 378,750.00 | | |

Custer Telephone Broadband Services LLC

Fiber to the Home Project Boundary 2020-2021

Legend

 Feature 1



Salmon

Maple St

Idaho Ave

Lemhi Ave

Hope Ave

Union Ave

Main St

Mary St

E Main St

Bean St

Sho St

Adams Dr

Gettonwood Rd

Cemetery St

Parview Rd

Island Farm Rd

Dangle Ln

Lovers Ln

Havens Ln

Elk Ln

Rays Ln

King Bee Ln

S St Charles St

Parson

Demick Ln

Cemetery Ln



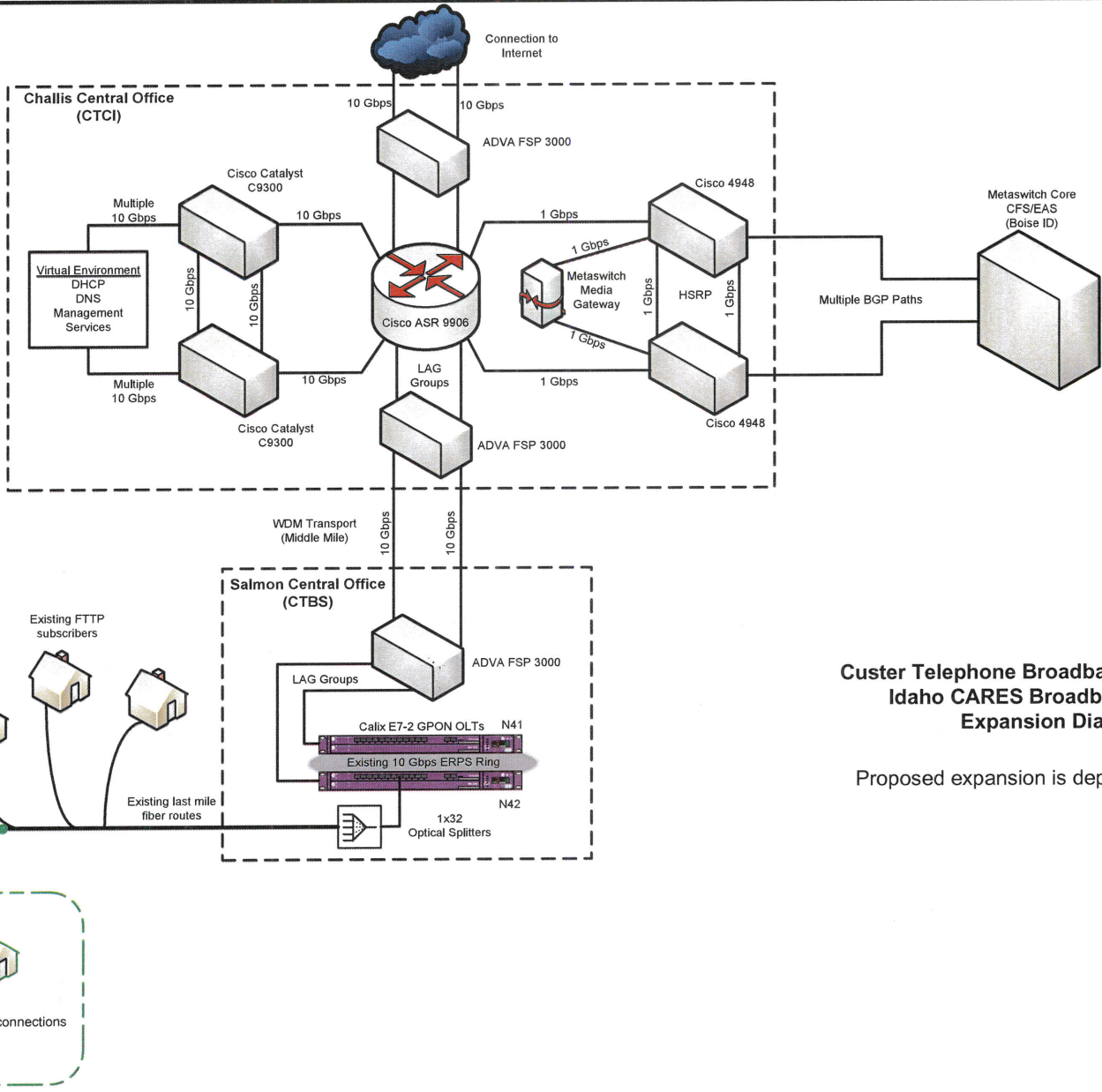

**Custer Telephone Broadband Services, LLC
Idaho CARES Broadband Network
Expansion Diagram**

Proposed expansion is depicted in GREEN

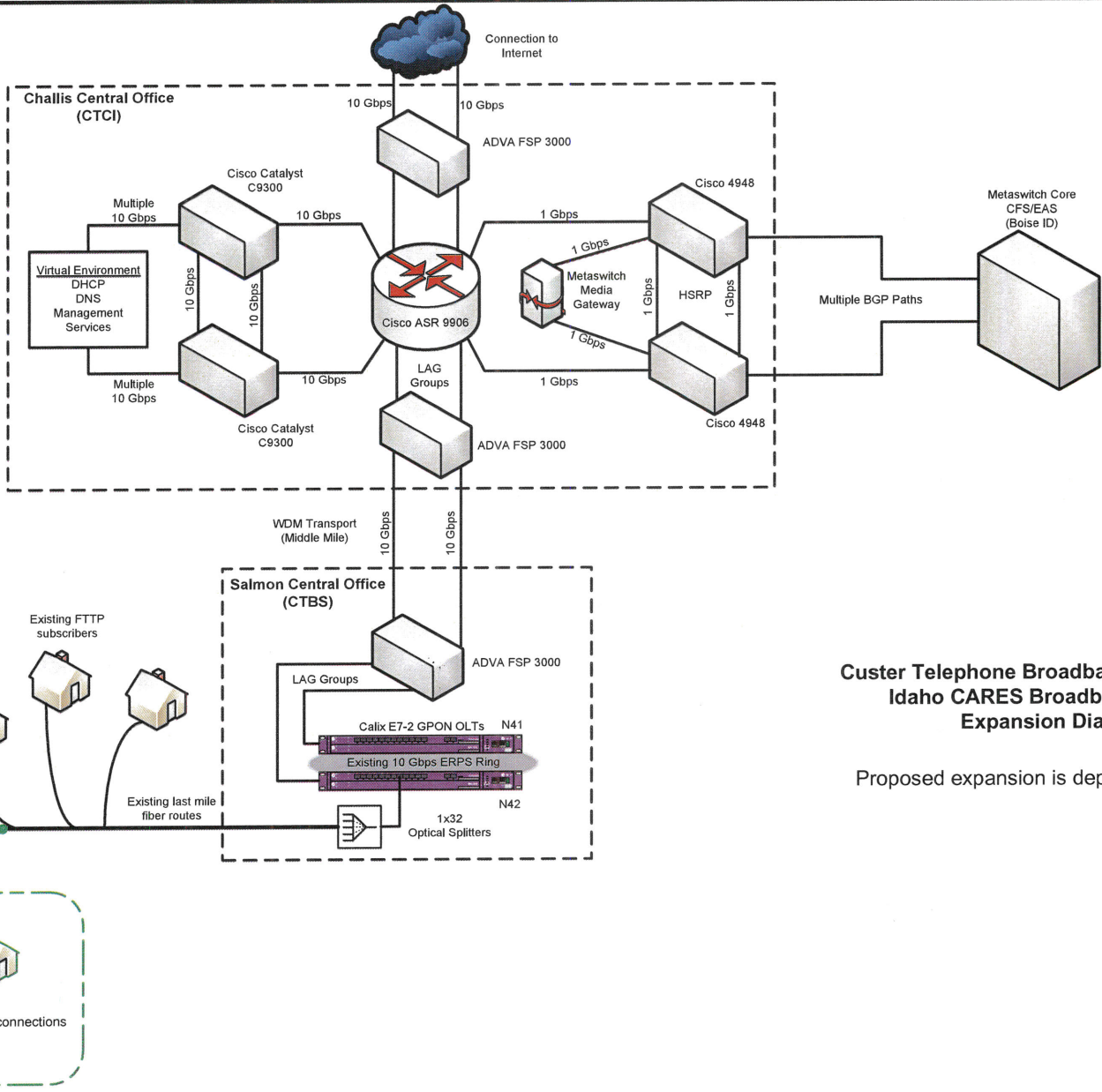

**Custer Telephone Broadband Services, LLC
Idaho CARES Broadband Network
Expansion Diagram**

Proposed expansion is depicted in GREEN



Account 729900
Location ID 729900:2 BENNETT LN
Phone No. [REDACTED]
Email [REDACTED]
Address 2 BENNETT LN, SALMON, ID, USA

Speed Test (ran 0 second ago)



[OOKLA Privacy Policy](#)

✔ Download Speed 27.88 Mbps (Good). Upload Speed 4.65 Mbps (Good)

Download Speed



| | |
|-------------|------------------------------------|
| Account | 679900 |
| Location ID | 679900:32 ISLAND FARM RD |
| Phone No. | [REDACTED] |
| Email | [REDACTED] |
| Address | 32 ISLAND FARM RD, SALMON, ID, USA |

Speed Test (ran 0 second ago)



[OOKLA Privacy Policy](#)

✔ Download Speed 25.95 Mbps (Good). Upload Speed 3.81 Mbps (Good)

Download Speed



| | |
|-------------|-------------|
| Account | [REDACTED] |
| Location ID | 13262-2 |
| Phone No. | - |
| Email | - |
| Address | 38 Loves Ln |

Speed Test (ran 0 second ago)



[OOKLA Privacy Policy](#)

✔ Download Speed 10.26 Mbps (Good). Upload Speed 1.05 Mbps (Good)

Download Speed

[REDACTED]

| | |
|-------------|-------------------------------|
| Account | 889200 |
| Location ID | 889200:22 LOVERS LN |
| Phone No. | [REDACTED] |
| Email | [REDACTED] |
| Address | 22 LOVERS LN, SALMON, ID, USA |

Speed Test (ran 0 second ago)

 **SPEEDTEST** powered

[OOKLA Privacy Policy](#)

✔ Download Speed 10.24 Mbps (Good). Upload Speed 1.39 Mbps (Good)

Download Speed



| | |
|-------------|--|
| Account | 752400 |
| Location ID | 752400:37 LOVERS LN |
| Phone No. |  |
| Email | - |
| Address | 37 LOVERS LN, SALMON, ID, USA |

Speed Test (ran 0 second ago)



[OOKLA Privacy Policy](#)

✔ Download Speed 10.48 Mbps (Good). Upload Speed 1.32 Mbps (Good)

Download Speed



| | |
|-------------|------------------------------------|
| Account | 914400 |
| Location ID | 914400;44 WAGON WHEEL RD |
| Phone No. | [REDACTED] |
| Email | [REDACTED] |
| Address | 44 WAGON WHEEL RD, SALMON, ID, USA |

Speed Test (ran 0 second ago)



[OOKLA Privacy Policy](#)

✔ Download Speed 26.23 Mbps (Good). Upload Speed 3.7 Mbps (Good)

Download Speed



| | |
|-------------|------------------------------------|
| Account | 510300 |
| Location ID | 510300:47 WAGON WHEEL RD |
| Phone No. | [REDACTED] |
| Email | [REDACTED] |
| Address | 47 WAGON WHEEL RD, SALMON, ID, USA |

Speed Test (ran 0 second ago)



[OOKLA Privacy Policy](#)

✔ Download Speed 25.85 Mbps (Good). Upload Speed 3.89 Mbps (Good)

Download Speed



| | |
|-------------|-------------------|
| Account | |
| Location ID | 12268 |
| Phone No. | - |
| Email | - |
| Address | 48 Wagon Wheel Rd |

Speed Test (ran 0 second ago)



[OOKLA Privacy Policy](#)

Download Speed 5.33 Mbps . Upload Speed 1.84 Mbps

Download Speed



Account 673800
Location ID 673800:11 DANCE LN
Phone No. [REDACTED]
Email [REDACTED]
Address 11 DANCE LN, SALMON, ID, USA

Speed Test (ran 0 second ago)



[OOKLA Privacy Policy](#)

✔ Download Speed 16.64 Mbps (Good). Upload Speed 1.25 Mbps (Good)

Download Speed



| | |
|-------------|--|
| Account | 942300 |
| Location ID | 942300:7 ADAMS DR |
| Phone No. |  |
| Email | - |
| Address | 7 ADAMS DR, SALMON, ID, USA |

Speed Test (ran 0 second ago)



[OOKLA Privacy Policy](#)

✔ Download Speed 11.81 Mbps (Good). Upload Speed 1.84 Mbps (Good)

Download Speed

Idaho Broadband Fund: CARES Act Broadband Grant

| | |
|-------------------|---|
| Applicant | Mandy Pomeroy |
| Applicant ID | APP-004815 |
| Company Name | Blaine County |
| Recipient Address | Blaine County 206 S 1st Ave Hailey Hailey, ID 83333 |
| Phone | (208) 788-5547 |
| Email | mpomeroy@co.blaine.id.us |
| Amount Requested | \$1,519,234.00 |
| Status | Submitted |
| Funded | <input type="checkbox"/> |

Application Title: Carey Household Broadband

Applicant Information

NOTICE: Grant applications, challenges, and responses to challenges will be posted to the Idaho Department of Commerce website

1. Program Description

The Idaho Broadband Advisory Board is soliciting projects that meet the CARES Act funding criteria for the \$10 million appropriated to the Idaho Department of Commerce from the Federal COVID Relief Fund. These funds may only be expended to provide financial assistance in broadband infrastructure consistent with CARES Act criteria. The Idaho Broadband Advisory Board seeks to fund broadband projects across the state that are necessary for the COVID-19 public health emergency, and may include assisting with or improving distance learning, telehealth, telework, and public safety. This Idaho Broadband Fund: CARES Act Broadband Grant (the "Broadband Grant") is designed to meet the CARES Act criteria, helping Idaho rebound from the COVID-19 public health emergency.

Question: Applicant's contact information: a. Name b. Title/Position c. Mailing Address d. Email Address e. Phone Number

Dick Fosbury, Chairman Blaine Co Commissioners, 206 S 1st Ave Hailey, ID 83333
rfosbury@blainecounty.org 208-720-2352

Mike Higgs, Chairman Carey-Picabo Chamber of Commerce, POB 220 Carey, ID 83320
sondancemike@gmail.com 503-805-1280

Harry Griffith, ED Sun Valley Economic Development, POB 3893 Ketchum, ID 83340
harry@sunvalleyeconomy.org 208-721-7847

Question: List the cities/communities in the census blocks where the project(s) will take place.

CareyID

Question: Grant Administrator a. Provide the name and title of the designated grant administrator. b. Provide the email address of the designated grant administrator. c. Provide the phone number of the designated grant administrator.

Stephan McDougal-Graham, Grants & Procurement Specialist, smgraham@co.blaine.id.us ,
208-788-5586

Project Requirements

2. Eligible Projects

A. To be eligible for funding under the Broadband Grant, projects must meet the following eligibility criteria:

- Projects must satisfy the CARES Act criteria, which is designed to address key areas of public health and safety by improving opportunities to telework, improving access to telehealth services, facilitating distance learning, and improving public safety (CARES Act Federal Register Guidance can be found here. Frequently asked questions can be referenced here.)
- Projects must be necessary due to the COVID-19 public health emergency.
- Projects must expand rural broadband capacity to assist with telework, telehealth, distance learning, and public safety. Projects that would not be expected to increase capacity to a significant extent until the need for telework, telehealth, distance learning, and public safety have passed due to this public health emergency would not be necessary due to the public health emergency and therefore would not be eligible uses of Broadband Grant funds. Projects must provide broadband service within the proposed project areas.
- Projects must be completed and operable and verified no later than December 31, 2021. **Projects that are not completed, operable, and verified by December 31, 2021 will not be reimbursed.**
- Include broadband infrastructure and equipment costs meeting CARES Act criteria. Satellite service is not eligible for grant award.

Eligible applicants may apply for multiple grants. County governments may apply for grants on behalf of unincorporated communities.

Question: Does your project meet the CARES Act criteria?

Yes

No

Question: I understand that the State of Idaho will provide no funding and have no obligations for CARES funded projects that fail to be completed by December 31, 2021.

Yes

No

Scored Criteria

Scored Criteria

1. Provide an overview of the project, including why the project is important and how it will address the broadband needs of the community. Include a scope of work description, along with a list of ISPs that can provide: the broadband service being sought, the required technologies and equipment, and the installation and operation of the new broadband service. (30 Points)
 - a. Scope of Work: outlines the detailed plans of the infrastructure build. This may include, but is not limited to, the following: project area, type of infrastructure installed, locations of underserved households, known existing infrastructure, known existing anchor institutions (schools, hospitals, public facilities, etc.), potential middle-mile infrastructure that will be utilized, and locations of existing infrastructure.
2. Explain how the project will promote equal access in economic development, public safety, telehealth, education, including why current infrastructure is inadequate or negatively impacts the community? (25 Points)
3. Explain how your project meets Cares Act Criteria, is necessary for the public health emergency, and mitigates similar disruptions in the future? (20 Points).
4. Will this project deliver broadband infrastructure to a rural Idaho population (less than 25,000) (Y/N) (15 Points).
5. Explain how your project delivers a cost-effective broadband infrastructure solution to the community (10 Points).

Question: Provide an overview of the project, including why the project is important and how it will address the broadband needs of the community. Include a scope of work description, along with a list of ISPs that can provide the proposed service.

Carey is underserved with limited broadband. The only available service for residential households is line of sight from the watertower, or satellite with speeds lower than 25/10. This community of 460 people serves as a bedroom community for the broader Wood River Valley. Many of the areas service and trades workers reside in Carey due to affordable housing costs and commute each day to jobs in Bellevue, Hailey, Ketchum and Sun Valley. With median home prices in Carey at \$250k compared with Hailey's \$350k and Ketchum/SV's \$950k, home ownership is more accessible in this more distant rural community. The Carey demographic has a large number of children per household and access to telelearning is critical in a post pandemic world. With the nearest medical clinic 45 minutes away in Hailey, telehealth through the St Lukes system is also important.

Anthem (formerly Safelink) is the only land line ISP serving the immediate area. They control the fiber route from Picabo to Carey funded by a prior CARES grant award for Public Safety to the Carey City Hall and fairgrounds community access. This deployment would put fiber throughout the city center along existing road and rights of way, with potential to serve 253 households. Anthem will be offering 2 speed packages, a 100Mx100M package for \$65/month and a 1000Mx1000M package for \$99/month with no additional equipment rental. There is also the Emergency Broadband Benefit program that will be available that will discount the 100M package to \$10/month instead while that is active if the customer qualifies for the program. This

is a lower price than our normal packages offered for fiber customers at \$74 (plus 9.95 equipment rental) for 100M and \$249 (plus 9.95 equipment rental) for 1000M service.

Anthem will have service available to all of the 253 homes built by the end of the construction period in December. They anticipate a minimum of 50 homes connected before the end of the year with the remaining that wish to be connected to be installed in Spring 2022 after winter snow melt.

Question: Explain how the project will promote equal access in economic development, public safety, telehealth, education, including why current infrastructure is inadequate or negatively impacts the community?

Carey has historically been a remote underserved community within Blaine. Traditionally, agriculture has been the main stay of the community with very limited economic diversity. Carey's population decreased significantly in the immediate aftermath of the Great Recession. The Great Recession also caused significant stress in the non-agriculture business ecosystem, with numerous closures including its only grocery store 4 years ago.

The Zoom town revitalization of Idaho mountain communities like Sun Valley is poised to have a positive knockon effect on Carey's prospects. With home prices in Ketchum growing 30% through the pandemic, the only available lower priced land and housing stock is in more remote communities like Carey. Previously moribund undeveloped sub divisions are now selling to newcomers. Development of broadband should make Carey much more attractive place for remote workers.

Question: Explain how your project meets Cares Act Criteria, is necessary for the public health emergency, and mitigates similar disruptions in the future?

Between the last CARES grant allocation for public safety and this proposed grant for households, Carey government and resident's access to education, medical advice and ability to react to wildfires and other unexpected events will be significantly improved.

The Fire Department at the north edge of Carey currently only has line of sight connectivity via wifi from the water tower. With current access speeds of 9/2, the Fire Dept struggles to connect to the internet for access with Blaine Co fire departments, regional and national wildfire response organizations, access to Incidweb reporting and other critical interfaces.

Connectivity to the broader world for Carey households and Fire can help convert this predominately rural agricultural community into a more vibrant and safer place to live, work and recreate.

Question: Will this project deliver broadband infrastructure to a rural Idaho population (less than 25,000)?

Yes

No

Question: Explain how your project delivers a cost-effective broadband infrastructure solution to the community?

At an estimated costs of \$6000 per household, this project should be reasonably cost competitive with other rural Idaho towns. Anthem's proposed pricing plan (see Q4 above) should make this package very attractive to households where the median income is less then \$50,000.

Additional Requested Information (if applicable)

Question: Please detail any project match included to complete this project.

Anthem has committed \$69,762 in match dollars to this project. This amount reflects access electronics needed by housholds to connect. Normally, these would be on a lease arrangement.

Question: Estimated total project cost?

1519234.00

Question: Number of households that will be connected to broadband service under the scope of the grant if applicable? If not applicable please answer N/A.

253

Question: What is the average cost per household of new broadband service based on this project cost if applicable? If not applicable please answer N/A.

6028

Question: What is the maximum broadband speed that will be provided by the project?

1 Gig up and down

Question: Are permits, permissions, and zoning requirements all obtainable in order for the project to be completed and paid for by December 31, 2021 if it is a CARES funded project? Please provide details.

Right of way approvals have been provided by the City of Carey. No other permits permissions or zoning changes are required.

Question: Please describe who will be providing the broadband service and ownership of the broadband infrastructure..

Anthem Broadband

Question: Describe how the project will be administered and audited for completion, and how the accounting will be performed.

The Carey-Picabo Chamberof Commerce and Sun Valley Economic Development are jointly administering the project. CPCC is interfacing with the ISP and gathering input data so SVED

can complete the application and support with the Blaine Co commissioners. The CPCC will monitor build out and SVED will audit project closing documentation prior to submittal for reimbursement. Blaine Co will act as the fiscal agent for grant submittal and funds disbursement.

Question: Has your project area received or been awarded any federal funds (CAFII/RDOF/USDA Reconnect) in the past two years, or will it receive federal funding over the next two years? If so, explain why additional funding was/is necessary in the project area?

No

Question: Has your project area received state funds (Cares Act Broadband Grants, E-Rate, etc.) in the past two years? If so, please explain what state funds were received and why the additional state funding was necessary in the project area.

As mentioned, Carey received CARES Broadband grant totalling \$652k in FY20. That funding allowed for construction of broadband fiber from Picabo to Carey City Hall with wifi repeater coverage to the public fairgrounds. Connectivity to this infrastructure was made for City of Carey public safety networks and government. This grant application seeks to complete a household buildout not contemplated or covered in the last grant cycle.

Question: Include any other relevant information as to why your project should be considered for funding.

Providing work-live affordable housing stock and broadband equality to a currently underserved population will help to alleviate the divide between those that don't need to work and those that need to. As the 10th worst income equality county in the US, leveling the playing field by expanding infrastructure for the economically most vulnerable is an important policy tool which will benefit the people of Carey.

Question: Submit 10 or more, recent, fixed location Speed Tests. Applicants can choose which speedtest application to use across the proposed project area (if applicable).

[20516 N Main St Safelink 6-1 \(1\).jpg](#) (7/15/2021 5:59 PM)

[20470 Main St Safelink 10-2.jpg](#) (7/15/2021 5:58 PM)

[20449 N Main St Verizon.jpg](#) (7/15/2021 5:58 PM)

[20439 N Main St Ziplly 20-5.jpg](#) (7/15/2021 5:58 PM)

[20431 N Main St Ziplly 10-3.jpg](#) (7/15/2021 5:57 PM)

[341 Green Field Way Safelink 25-5.jpg](#) (7/15/2021 5:57 PM)

[105 Greenfield Way Safelink 5-1.jpg](#) (7/15/2021 5:56 PM)

[6 4th St Safelink 10-2.jpg](#) (7/15/2021 5:56 PM)

[2 Carey Ave Safelink 10-2.jpg](#) (7/15/2021 5:56 PM)

[20531 N Main St Safelink 15-3.jpg](#) (7/15/2021 5:55 PM)

Attachments & Additional Supporting Documents

Upload Required Attachments & Additional Supporting Documents

Project Attachment Templates:
CARES Act Certification

[Grant Budget Template](#)
[Project Schedule Form](#)
[Letters of Support/Community match template](#)

Question: Project Area Identification Documentation: Applicant must upload supporting documents identifying the scope of work for the proposed project(s). Applicant must include 1Pdf & 1Shape/Kmz map clearly showing the location and details of the proposed project.

[Idaho Broadband Grant Application KML \(1\).kml](#) (7/16/2021 2:29 PM)
[Carey Cares2 Image.jpg](#) (7/11/2021 5:08 PM)

Question: Grant Budget Template: Complete, upload, and attach to the application a completed Grant Budget Template for the project that outlines each of the various costs.

[Carey Cares2 Cost Matrix.pdf](#) (7/11/2021 5:09 PM)

Question: Project Schedule Form: Complete, upload, and attach to the application the Project Schedule Form.

[Carey HH Broadband Grant Program Schedule.pdf](#) (7/16/2021 2:20 PM)

Question: CARES Act Certification: Upload and attach to the application a notarized CARES Act Certification that this project meets the CARES Act criteria.

[Carey FY22 IDC Broadband Certification 7.13.21.pdf](#) (7/14/2021 4:53 PM)

Question: Letters of Support: Upload and attach to the application any Letters of Support or Community Match documentation. (if applicable)

[Carey FY22 IDC Broadband Ltr of Support 7.13.21.pdf](#) (7/14/2021 4:53 PM)
[Carey Picabo Grant Support Request.docx](#) (7/11/2021 5:10 PM)

Question: Letters of Commitments from Anchor Institutions: Upload and attach to application letters of commitments from community anchor institutions or public safety networks which will utilize your service if the project is funded. (if applicable)

No Attachments

Question: Community Broadband Plan: Upload and attach a copy of your Community Broadband Plan (if applicable).

No Attachments

Question: Any applicable Site Plans, studies, or photographs.

No Attachments

Signature

Your identity has been authenticated through the login process with a unique email address and password available only to you. You agree that by typing your name, title and date below, you are electronically signing the application. By electronically signing the application, you acknowledge and represent that you understand and accept all the terms and conditions stated within the application and declare that the information provided is true and that the documents you are submitting in support of your application are genuine and have not been altered in any way.

Question: Type your name.

harry Griffith

Question: Type your title.

ED, SunValley Economic Development

Question: Type the submission date.

7/16/2021



SPEEDTEST

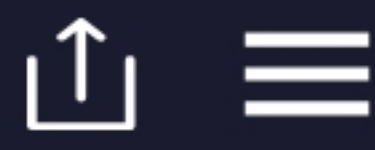

📶 DOWNLOAD Mbps

📶 UPLOAD Mbps

7.83

1.79

📶 Ping 52ms

📶 Jitter 222ms

📶 Loss 0.0%



📶 Safelink Internet Services

[Test Again](#)

RATE YOUR PROVIDER
SAFELINK INTERNET SERVICES



BALEAF

KICK YOUR RUN INTO HIGH GEAR

amazon



Speed



Video



VPN

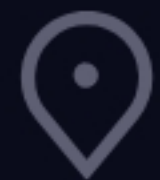

Map





SPEEDTEST

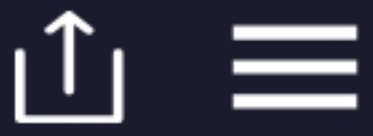

DOWNLOAD Mbps

UPLOAD Mbps

10.1

2.04

Ping 34ms

Jitter 7ms

Loss 0.0%

Safelink Internet Services

Test Again

HOW LIKELY IS IT THAT YOU WOULD RECOMMEND SAMSUNG DEVICES TO A FRIEND OR COLLEAGUE?

| | | | | | | | | | | |
|---|---|---|---|---|---|---|---|---|---|----|
| 0 | 1 | 2 | 3 | 4 | 5 | 6 | 7 | 8 | 9 | 10 |
|---|---|---|---|---|---|---|---|---|---|----|

Not at all likely

Extremely Likely

Fast Internet No Limits

Are you Tired of Slow Speeds?

City/Rural Internet that works. Call Now or Visit website today to get fast Internet

kioskwireless.com

OPEN

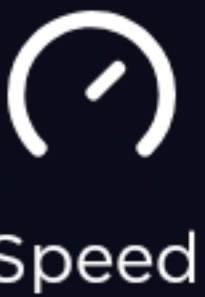

Speed



Video



VPN



Map





SPEEDTEST

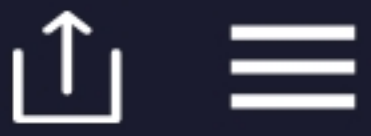

DOWNLOAD Mbps

UPLOAD Mbps

4.21

0.97

Ping 37ms

Jitter 38ms

Loss 0.0%

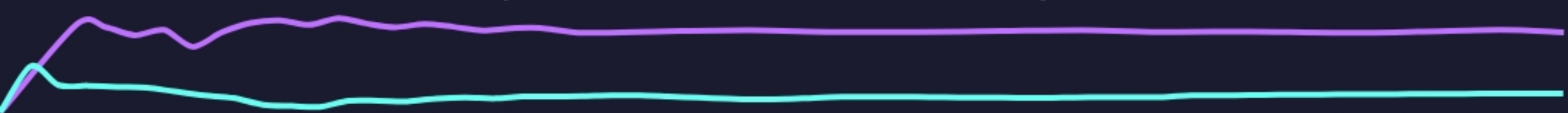

Safelink Internet Services

[Test Again](#)

HOW DOES THE CUSTOMER SERVICE OF SAFELINK INTERNET SERVICES COMPARE WITH YOUR EXPECTATIONS?

| | | | | |
|------------|---|-------------|---|-------------|
| 1 | 2 | 3 | 4 | 5 |
| Much worse | | As expected | | Much better |

×

×

Kiosk Wireless Speed Internet

Slow? Join something New

We Offer 4 Plans on Our High-Speed 4G Network to Choose From in Mini-Cassia

kioskwireless.com

OPEN



Speed



Video



VPN



Map



📶 DOWNLOAD Mbps

📶 UPLOAD Mbps

17.8

5.96

📶 Ping 78ms

📶 Jitter 37ms

📶 Loss 0.0%



📶 Safelink Internet Services

Test Again

HOW LIKELY IS IT THAT YOU WOULD RECOMMEND SAMSUNG DEVICES TO A FRIEND OR COLLEAGUE?

| | | | | | | | | | | |
|---|---|---|---|---|---|---|---|---|---|----|
| 0 | 1 | 2 | 3 | 4 | 5 | 6 | 7 | 8 | 9 | 10 |
|---|---|---|---|---|---|---|---|---|---|----|

Not at all likely

Extremely Likely



Fast Internet No Limits

Are you Tired of Slow Speeds?

City/Rural Internet that works. Call Now or Visit website today to get fast Internet

kioskwireless.com

OPEN



Speed



Video



VPN



Map





Your Internet speed is

7.6 Mbps



Latency

Unloaded

Loaded

56 ms

109 ms

Upload

Speed

1.3 Mbps

Client Fairfield, US 50.37.197.209
Server(s) Seattle, US | Hillsboro, US

Settings

8.2MB

3.8MB





SPEEDTEST

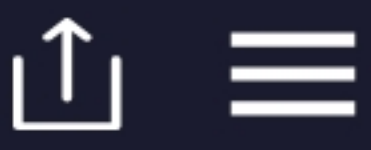

DOWNLOAD Mbps

UPLOAD Mbps

9.05

0.68

Ping 61ms

Jitter 2ms

Loss 5.9%

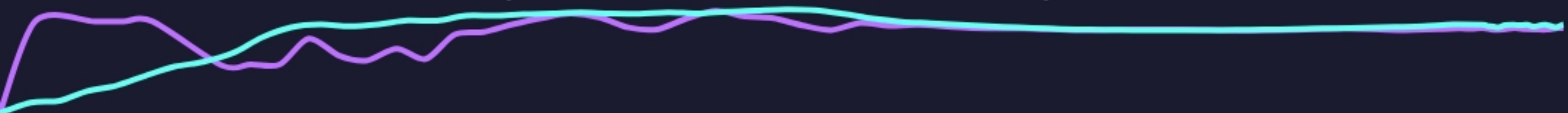

Ziplay Fiber

Test Again

HOW DOES YOUR DOWNLOAD SPEED COMPARE WITH YOUR EXPECTATIONS?

| | | | | |
|------------|---|-------------|---|-------------|
| 1 | 2 | 3 | 4 | 5 |
| Much worse | | As expected | | Much better |

FREE

PICK-UP
AND
DELIVERY
FOR SERVICE







Speed



Video



VPN



Map



SPEEDTEST



⬇️ DOWNLOAD Mbps

9.26

📶 Ping 68 ms

👤 Verizon

Test Again

SPEEDTEST[®] for iOS & iPadOS

- ⬇️ Advanced speed metrics
- 🌐 Server selection
- ✅ Results history



 Download on the
App Store



SPEEDTEST

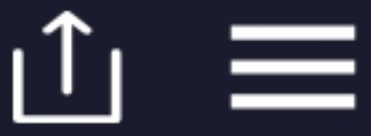

DOWNLOAD Mbps

UPLOAD Mbps

9.01

2.02

Ping 31ms

Jitter 48ms

Loss 0.7%

Safelink Internet Services

Test Again

HOW LIKELY IS IT THAT YOU WOULD RECOMMEND SAFELINK INTERNET SERVICES TO A FRIEND OR COLLEAGUE?

| | | | | | | | | | | |
|---|---|---|---|---|---|---|---|---|---|----|
| 0 | 1 | 2 | 3 | 4 | 5 | 6 | 7 | 8 | 9 | 10 |
|---|---|---|---|---|---|---|---|---|---|----|

Not at all likely

Extremely Likely

×
▶ ×

Fast Internet No Limits

Are you Tired of Slow Speeds?

City/Rural Internet that works. Call Now or Visit website today to get fast Internet

kioskwireless.com

OPEN



Speed



Video



VPN



Map





SPEEDTEST



DOWNLOAD Mbps

UPLOAD Mbps

5.35

0.93

Ping 37ms

Jitter 31ms

Loss 1.7%



Safelink Internet Services

Test Again

HOW LIKELY IS IT THAT YOU WOULD RECOMMEND SAFELINK INTERNET SERVICES TO A FRIEND OR COLLEAGUE?

- 0
- 1
- 2
- 3
- 4
- 5
- 6
- 7
- 8
- 9
- 10

Not at all likely

Extremely Likely





[Plant Stand, Carkoci 2 Pack Wood ...](#)

★★★★★ (3)

\$29.79



Speed



Video



VPN

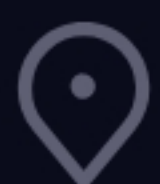

Map





SPEEDTEST



DOWNLOAD Mbps

UPLOAD Mbps

13.4

2.88

Ping 38ms

Jitter 9ms

Loss 1.1%



Safelink Internet Services

Test Again

RATE YOUR PROVIDER
SAFELINK INTERNET SERVICES





**A REWARDING
CAREER IN
SKILLED TRADE**

A highly rewarding,
lucrative, and flexible
career choice.

APPLY TODAY >



Speed



Video



VPN



Map



| Line Item | Grant Dollars | Match Dollars | Total |
|-------------------------|---------------|---------------|--------------|
| Carey FTTH Construction | \$ 925,846 | | \$ 925,846 |
| Construction Materials | \$ 266,775 | | \$ 266,775 |
| Splicing | \$ 110,250 | | \$ 110,250 |
| ONTs | \$ 141,601 | | \$ 141,601 |
| Electronics | | \$ 69,762 | \$ 69,762 |
| Grant Admin | \$ 5,000 | | \$ 5,000 |
| Totals | \$ 1,449,472 | \$ 69,762 | \$ 1,519,234 |

Carey Idaho CARES

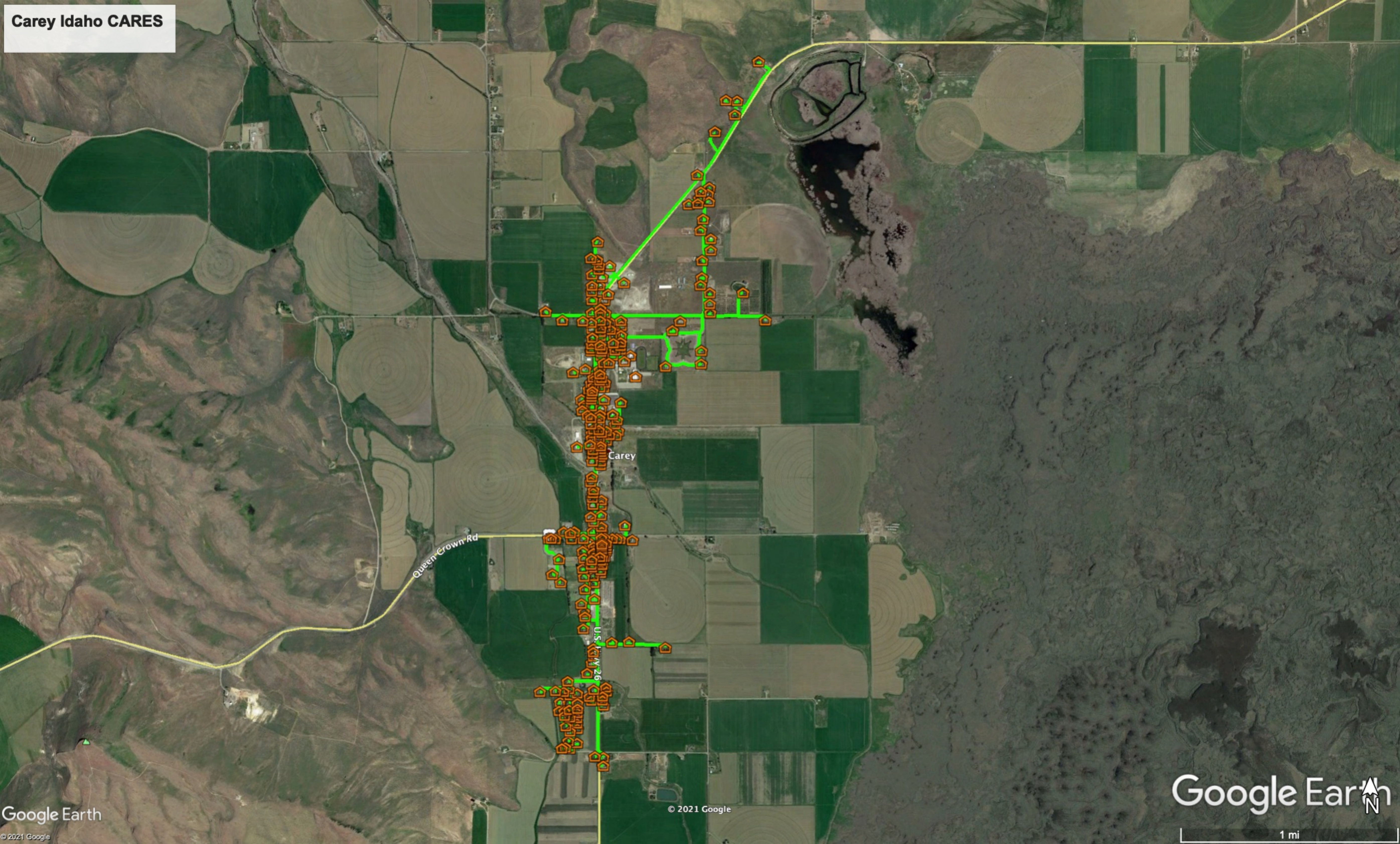



THE BOARD OF BLAINE COUNTY COMMISSIONERS

206 FIRST AVENUE SOUTH, SUITE 300

HAILEY, IDAHO 83333

PHONE: (208) 788-5500 FAX: (208) 788-5569

www.blainecounty.org bcc@co.blaine.id.us

Dick Fosbury, Chairman * Angenie McCleary, Vice-Chair * Jacob Greenberg, Commissioner

State of Idaho Broadband Grant CARES Act Certification

STATE OF Idaho
COUNTY OF Blaine

The undersigned, Dick Fosbury, representing Blaine County, Idaho, hereby swear (affirm) that:

- 1. I am Chairman of The Board of Blaine County Commissioners and thereby authorized to make these statements.
2. I have personal knowledge of the facts herein, and can testify completely thereto.
3. The purpose of this statement is to assure the Idaho Department of Commerce that the project will meet the CARES Act Criteria.
i. Expenses to facilitate distance learning, including technological improvements, in connection with school closings to enable compliance with COVID-19 precautions.
ii. Expenses to improve telework capabilities for public employees to enable compliance with COVID-19 public health precautions.

The proposed project will expand high-speed fiber access from the existing route serving Carey City Hall and Fire Department to serve up to 253 additional households with maximum broadband speeds of up to 1 Gigabyte/sec. The increased connectivity will improve this underserved rural community's access to telehealth, telelearning, and telework services and opportunities, providing support for local economic development and address the disproportionate health and economic impacts of the COVID-19 pandemic suffered by the local residents.

Dick Fosbury
Signature
13 July 2021

Date

SUBSCRIBED AND SWORN before me on this 13 day of July

Notary Public for STATE Idaho

Residing at Blaine Co

Commission expires 9-17-22

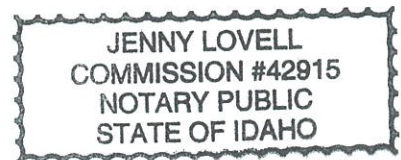



THE BOARD OF BLAINE COUNTY COMMISSIONERS

206 FIRST AVENUE SOUTH, SUITE 300

HAILEY, IDAHO 83333

PHONE: (208) 788-5500 FAX: (208) 788-5569

www.blainecounty.org bcc@co.blaine.id.us

Dick Fosbury, Chairman * Angenie McCleary, Vice-Chair * Jacob Greenberg, Commissioner

July 13, 2021

Idaho Department of Commerce
The Idaho Broadband Advisory Board
CC: Eric Forsch, Broadband Development Manager
700 W State St
Boise, Idaho 83702

Dear Advisory Board:

The Board of Blaine County Commissioners would like to express our support for the Carey Household Broadband project to be submitted to the Idaho Broadband Fund: CARES Act Broadband Grant program.

The proposed project will expand high-speed fiber access from the existing route serving Carey City Hall and Fire Department to serve up to 253 additional households with maximum broadband speeds of up to 1 Gigabyte/sec. The increased connectivity will improve this underserved rural community's access to telehealth, telelearning, and telework services and opportunities, providing support for local economic development and address the disproportionate health and economic impacts of the COVID-19 pandemic suffered by the local residents.

Located in southern Blaine County, Carey is the center of a vast agricultural community and home to several hundred residents. Carey is also home to the southernmost campus of the Blaine County School District, where K-12 enrollment tops 250 students. Many area residents commute long distances to their place of employment in the County's Wood River Valley to the north. With the cost of housing in the northern County communities increasing out of reach of many local workers, we anticipate a growth in the number of residents in Carey, and recognize the need for the local city infrastructure to expand to meet this future growth.

Blaine County has a strong working relationship with the City of Carey, Sun Valley Economic Development, and the Carey-Picabo Chamber of Commerce, and is supportive of their efforts to expand access to highspeed broadband services to our south County residents.

Sincerely,

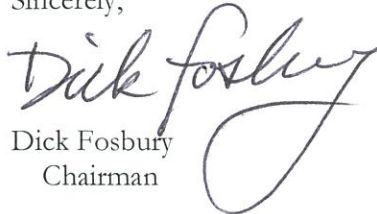
Dick Fosbury
Chairman

Angenie McCleary
Vice-Chairman

Jacob Greenberg
Commissioner

Idaho Broadband Grant Program - Carey, ID - Project Schedule

| Activity | Responsible Party | Start Date | End Date |
|--------------------------|----------------------|------------|----------|
| Grant Application | Blaine County | | 7/15/21 |
| Material Procurement | Anthem Broadband | 8/2/21 | 8/30/21 |
| Mobilization | SCI | 8/30/21 | 9/6/21 |
| Construction Begins | SCI | 9/6/21 | 12/15/21 |
| Weekly Progress Meetings | Anthem Broadband/SCI | 9/6/21 | 12/30/21 |
| Turnup and Testing | Anthem Broadband | 10/1/21 | 12/20/21 |
| Construction Cleanup | SCI | 9/6/21 | 12/15/21 |
| Certification | Anthem Broadband | 12/20/21 | 12/25/21 |

Carey-Picabo

Chamber of Commerce

A Chamber for **all** who live in the heart of the county

To: Blaine County Commissioners
From: Mike Higgs
Re: Carey application for CARES Broadband grant
Date: July 7, 2021

Grants for broadband development are once again available through the CARES Act, and the City of Carey is preparing to submit an application. Thanks in part to the support of our Commissioners, Carey was able to receive a grant in 2020 that provided fiber optic cable to Carey and very high speed, public access internet to the Carey City Hall and Blaine County Fairgrounds. As we prepare our “fiber to the curb” grant, we once again request your support.

Reliable, high-speed internet access to any community, be it urban, suburban or rural, is now considered “essential infrastructure.” The COVID-19 pandemic has only emphasized the importance of this, as “live where you work” continues to transition to “work where you live.” In Blaine County, our ongoing affordable housing challenges make Carey an increasingly attractive option for those who can’t afford Wood River Valley housing. Infrastructure for a new subdivision in Carey is being installed this summer, and another potential subdivision is going through P&Z. Work on a new grocery store is ongoing, the old Paris Hotel eyesore has been demolished, and Itty Bitty Farms is flourishing. Good things are happening in Carey!

We are working with Anthem Broadband (formerly Safelink) to develop a “fiber to the curb” proposal that would expand on the work done with our earlier grant, and run fiber optic cable down all streets within the city limits. Because of the number of homes in Carey, and how spread out the community is, “fiber-to-the-door,” like our Picabo grant in 2020 was able to accomplish, bumps the price tag above what we feel is competitive statewide. According to Anthem, the cost of connecting customers when fiber is so close will not be prohibitive.

We plan on stewarding this grant through the process in the same way we did for the 2020 grants; I will work closely with Harry Griffith, he will be the point person in getting our application completed and submitted, and I will be the point person in getting the project executed in Carey, should we receive a grant. There is a \$10 million grant opportunity in 2021, and another \$35 million opportunity in 2022. We will give 2021 a shot and if not successful, do it again in 2022. In either case, a letter of support from our Commissioners would be a great asset for us in the application process!

With Gratitude,

Mike Higgs
Carey-Picabo Chamber of Commerce